

E4980A Precision LCR Meter

20 Hz to 2 MHz

E4980AL Precision LCR Meter

20 Hz to 300 kHz/500 kHz/1 MHz



Fully compliant to
LXI Class C specification

Table of Contents

Definitions	3
How to Use Tables	3
E4980A/E4980AL	3
Basic Specifications	4
Measurement functions	4
Test signal	5
Measurement display ranges	7
Absolute measurement accuracy	8
Relative accuracy	10
Basic accuracy	13
Short offset Z_s	15
Open offset Y_o	16
Calibration accuracy A_{cal}	17
Measurement accuracy	19
Compensation function	20
DC bias signal	21
Measurement assistance functions	21
Options	22
Frequency options	22
Interface options	23
Other options	23
Power and DC bias enhancement specification	23
Test signal	24
DCR measurement specification	28
General Specifications	30
Supplemental Information	35
Settling time	35
Measurement circuit protection	36
Measurement time	36
Display time	40
Measurement data transfer time	41
Maximum DC bias current	42
Relative measurement accuracy with bias current isolation	43
DC bias settling time	44
Web Resources	45

Definitions

All specifications apply to the conditions of a 0 to 55°C temperature range, unless otherwise stated, and 30 minutes after the instrument has been turned on.

Specifications (spec.): Warranted performance. Specifications include guardbands to account for the expected statistical performance distribution, measurement uncertainties, and changes in performance due to environmental conditions.

Supplemental information is provided as information that is useful in operating the instrument, but is not covered by the product warranty. This information is classified as either typical or nominal.

Typical (typ.): Expected performance of an average unit without taking guardbands into account.

Nominal (nom.): A general descriptive term that does not imply a level of performance.

How to Use Tables

When measurement conditions fall under multiple categories in a table, apply the best value.

For example, basic accuracy A_b is 0.10% under the following conditions;

Measurement time mode	SHORT
Test frequency	125 Hz
Test signal voltage	0.3 Vrms

E4980A/E4980AL

The E4980A is the model number of the 20 Hz to 2 MHz frequency range LCR meter. The E4980AL is the model number of the 20 Hz to 300 kHz, 500 kHz or 1 MHz frequency range LCR meter. See the E4980A/E4980AL Configuration Guide (5989-8321EN) for more details.

Frequency range	Model number and option
20 Hz to 2 MHz	E4980A
20 Hz to 1 MHz	E4980AL-102
20 Hz to 500 kHz	E4980AL-052
20 Hz to 300 kHz	E4980AL-032

Basic Specifications

Measurement functions

Measurement parameters

- Cp-D, Cp-Q, Cp-G, Cp-Rp
- Cs-D, Cs-Q, Cs-Rs
- Lp-D, Lp-Q, Lp-G, Lp-Rp, Lp-Rdc
- Ls-D, Ls-Q, Ls-Rs, Ls-Rdc
- R-X
- Z- θ d, Z- θ r
- G-B
- Y- θ d, Y- θ r
- Vdc-Idc¹

Definitions

Cp	Capacitance value measured with parallel-equivalent circuit model
Cs	Capacitance value measured with series-equivalent circuit model
Lp	Inductance value measured with parallel-equivalent circuit model
Ls	Inductance value measured with series-equivalent circuit model
D	Dissipation factor
Q	Quality factor (inverse of D)
G	Equivalent parallel conductance measured with parallel-equivalent circuit model
Rp	Equivalent parallel resistance measured with parallel-equivalent circuit model
Rs	Equivalent series resistance measured with series-equivalent circuit model
Rdc	Direct-current resistance
R	Resistance
X	Reactance
Z	Impedance
Y	Admittance
θd	Phase angle of impedance/admittance (degree)
θr	Phase angle of impedance/admittance (radian)
B	Susceptance
Vdc	Direct-current voltage
Idc	Direct-current electricity

Deviation measurement function: Deviation from reference value and percentage of deviation from reference value can be output as the result.

Equivalent circuits for measurement: Parallel, Series

1. E4980A-001 is required.

Impedance range selection: Auto (auto range mode), manual (hold range mode)

Trigger mode: Internal trigger (INT), manual trigger (MAN), external trigger (EXT), GPIB trigger (BUS)

Range	0 s - 999 s
Resolution	100 μ s (0 s \leq - \leq 100 s) 1 ms (100 s < - \leq 999 s)

Table 1. Trigger delay time

Range	0 s - 999 s
Resolution	100 μ s (0 s \leq - \leq 100 s) 1 ms (100 s < - \leq 999 s)

Table 2. Step delay time

Measurement terminal: Four-terminal pair

Test cable length: 0 m, 1 m, 2 m, 4 m

Measurement time modes: Short mode, medium mode, long mode.

Range	1 - 256 measurements
Resolution	1

Table 3. Averaging

Test signal

Test frequencies	20 Hz - 2 MHz (E4980A) 20 Hz - 1 MHz (E4980AL-102) 20 Hz - 500 kHz (E4980AL-052) 20 Hz - 300 kHz (E4980AL-032)
Resolution	0.01 Hz (20 Hz - 99.99 Hz) 0.1 Hz (100 Hz - 999.9 Hz) 1 Hz (1 kHz - 9.999 kHz) 10 Hz (10 kHz - 99.99 kHz) 100 Hz (100 kHz - 999.9 kHz) 1 kHz (1 MHz - 2 MHz)
Measurement accuracy	\pm 0.01%

Table 4. Test frequencies

Normal	Program selected voltage or current at the measurement terminals when they are opened or short-circuited, respectively.
Constant	Maintains selected voltage or current at the device under test (DUT) independently of changes in impedance of DUT.

Table 5. Test signal modes

Signal level

Range	0 Vrms - 2.0 Vrms		
Resolution	100 μ Vrms (0 Vrms \leq - \leq 0.2 Vrms) 200 μ Vrms (0.2 Vrms < - \leq 0.5 Vrms) 500 μ Vrms (0.5 Vrms < - \leq 1 Vrms) 1 mVrms (1 Vrms < - \leq 2 Vrms)		
Accuracy	Normal	$\pm(10\% + 1 \text{ mVrms})$	Test frequency \leq 1 MHz: spec. Test frequency > 1 MHz: typ.
	Constant ¹	$\pm(6\% + 1 \text{ mVrms})$	Test frequency \leq 1 MHz: spec. Test frequency > 1 MHz: typ.

Table 6. Test signal voltage

Range	0 Arms - 20 mArms		
Resolution	1 μ Arms (0 Arms \leq - \leq 2 mArms) 2 μ Arms (2 mArms < - \leq 5 mArms) 5 μ Arms (5 mArms < - \leq 10 mArms) 10 μ Arms (10 mArms < - \leq 20 mArms)		
Accuracy	Normal	$\pm(10\% + 10 \mu\text{Arms})$	Test frequency \leq 1 MHz: spec. Test frequency > 1 MHz: typ.
	Constant ¹	$\pm(6\% + 10 \mu\text{Arms})$	Test frequency \leq 1 MHz: spec. Test frequency > 1 MHz: typ.

Table 7. Test signal current

Output impedance: 100 Ω (nominal)

Test signal level monitor function

- Test signal voltage and test signal current can be monitored.
- Level monitor accuracy:

1. When auto level control function is on.

Test signal voltage ²	Test frequency	Specification
5 mVrms - 2 Vrms	≤ 1 MHz > 1 MHz	±(3% of reading value + 0.5 mVrms) ±6% of reading value + 1 mVrms)

Table 8. Test signal voltage monitor accuracy (Vac)

Test signal current ²	Test frequency	Specification
50 μ Arms - 20 mArms	≤ 1 MHz > 1 MHz	±(3% of reading value + 5 μ Arms) ±(6% of reading value + 10 μ Arms)

Table 9. Test signal current monitor accuracy (Iac)

Measurement display ranges

Table 10 shows the range of measured value that can be displayed on the screen. For the effective measurement ranges, refer to Figure 1 impedance measurement accuracy example.

Parameter	Measurement display range
Cs, Cp	± 1.000000 aF to 999.9999 EF
Ls, Lp	±1.000000 aH to 999.9999 EH
D	±0.000001 to 9.999999
Q	±0.01 to 99999.99
R, Rs, Rp, X, Z, Rdc	±1.000000 a Ω to 999.9999 E Ω
G, B, Y	±1.000000 aS to 999.9999 ES
Vdc	±1.000000 aV to 999.9999 EV
Idc	±1.000000 aA to 999.9999 EA
θ_r	±1.000000 arad to 3.141593 rad
θ_d	±0.0001 deg to 180.0000 deg
$\Delta\%$	±0.0001% to 999.9999%

Table 10. Allowable display ranges for measured values

a: 1×10^{-18} , E: 1×10^{18}

1. When auto level control function is on.
2. This is not an output value but rather a displayed test signal level.

Absolute measurement accuracy

The following equations are used to calculate absolute accuracy.

Absolute accuracy Aa of |Z|, |Y|, L, C, R, X, G, B (L, C, X, and B accuracies apply when $D_x \leq 0.1$, R and G accuracies apply when $Q_x \leq 0.1$)

When $D_x \geq 0.1$, multiply Acal by $\sqrt{1+D_x^2}$ for L, C, X, and B accuracies

When $Q_x \geq 0.1$, multiply Acal by $\sqrt{1+Q_x^2}$ for R and G accuracies

Under an AC magnetic field, the following equation is applied to the measurement accuracy.

$$A \times (1 + B \times (2 + 0.5 / V_s))$$

where A Absolute accuracy
B Magnetic flux density [Gauss]
Vs Test signal voltage level [Volts]

Equation 1. $Aa = Ae + Acal$

Aa Absolute accuracy (% of reading value)
Ae Relative accuracy (% of reading value)
Acal Calibration accuracy (%)

where G accuracy is applied only to G-B measurements.

D accuracy (when $D_x \leq 0.1$)

Equation 2. $De + \theta_{cal}$

Dx Measured D value
De Relative accuracy of D
 θ_{cal} Calibration accuracy of θ (radian)

when $0.1 < D_x \leq 1$, multiply θ_{cal} by $(1 + D_x)$

Q accuracy (When $Q_x \times Da < 1$)

$$\text{Equation 3. } \pm \frac{(Q_x^2 \times Da)}{(1 \pm Q_x \times Da)}$$

Qx Measured Q value
Da Absolute accuracy of D

θ accuracy

Equation 4. $\theta_e + \theta_{cal}$

θ_e Relative accuracy of θ (degree)
 θ_{cal} Calibration accuracy of θ (degree)

G accuracy (when $D_x \leq 0.1$)

Equation 5. $B_x + Da$ (S)
$$B_x = 2\pi f C_x = \frac{1}{2\pi f L_x}$$

D_x Measured D value
 B_x Measured B value (S)
 Da Absolute accuracy of D
 f Test frequency (Hz)
 C_x Measured C value (F)
 L_x Measured L value (H)

where the accuracy of G is applied to Cp-G measurements.

Absolute accuracy of R_p (when $D_x \leq 0.1$)

Equation 6. $\pm \frac{R_{px} \times Da}{D_x \mp Da}$ (Ω)

R_{px} Measured R_p value (Ω)
 D_x Measured D value
 Da Absolute accuracy of D

Absolute accuracy of R_s (when $D_x \leq 0.1$)

Equation 7. $X_x \times Da$ (Ω)
$$X_x = \frac{1}{2\pi f C_x} = 2\pi f L_x$$

D_x Measured D value
 X_x Measured X value (Ω)
 Da Absolute accuracy of D
 f Test frequency (Hz)
 C_x Measured C value (F)
 L_x Measured L value (H)

Relative accuracy

Relative accuracy includes stability, temperature coefficient, linearity, repeatability, and calibration interpolation error. Relative accuracy is specified when all of the following conditions are satisfied:

- Warm-up time: 30 minutes
- Test cable length: 0 m, 1 m, 2 m, or 4 m (Keysight Technologies, Inc. 16048A/D/E)
- A “Signal Source Overload” warning does not appear. When the test signal current exceeds a value in table 11 below, a “Signal Source Overload” warning appears.

Test signal voltage	Test frequency	Condition ¹
≤ 2 Vrms	–	–
> 2 Vrms	≤ 1 MHz	The smaller value of either 110 mA or 130 mA - 0.0015 × Vac × (Fm / 1 MHz) × (L_cable + 0.5)
	> 1 MHz	70 mA - 0.0015 × Vac × (Fm / 1 MHz) × (L_cable + 0.5)

1. When the calculation result is a negative value, 0 A is applied.

Table 11.

Vac [V] Test signal voltage
Fm [Hz] Test frequency
L_cable [m] Cable length

- OPEN and SHORT corrections have been performed.
- Bias current isolation: Off
- The DC bias current does not exceed a set value within each range of the DC bias current
- The optimum impedance range is selected by matching the impedance of DUT to the effective measuring range.

|Z|, |Y|, L, C, R, X, G, and B accuracy (L, C, X, and B accuracies apply when $D_x \leq 0.1$, R and G accuracies apply $Q_x \leq 0.1$)

When $D_x > 0.1$, multiply A_e by $\sqrt{1+D_x^2}$ for L, C, X, and B accuracies

When $Q_x > 0.1$, multiply A_e by $\sqrt{1+Q_x^2}$ for R and G accuracies

Relative accuracy A_e is given as:

Equation 8. $A_e = [A_b + Z_s / |Z_m| \times 100 + Y_o \times |Z_m| \times 100] \times K_t$

Z_m Impedance of DUT
 A_b Basic accuracy
 Z_s Short offset
 Y_o Open offset
 K_t Temperature coefficient

D accuracy

D accuracy D_e is given as - when $D_x \leq 0.1$

Equation 9. $D_e = \pm A_e / 100$

D_x Measured D value
 A_e Relative accuracies of $|Z|$, $|Y|$, L, C, R, X, G, and B

When $0.1 < D_x \leq 1$, multiply D_e by $(1 + D_x)$

Q accuracy (when $Q \times D_e < 1$)

Q accuracy Q_e is given as:

Equation 10.
$$Q_e = \pm \frac{(Q_x^2 \times D_e)}{(1 \mp Q_x \times D_e)}$$

Q_x Measured Q value
 D_e Relative D accuracy

θ accuracy

θ accuracy θ_e is given as:

Equation 11.
$$\theta_e = \frac{180 \times A_e}{\pi \times 100} \text{ (deg)}$$

A_e Relative accuracies of $|Z|$, $|Y|$, L, C, R, X, G, and B

G accuracy (when $Dx \leq 0.1$)

G accuracy G_e is given as:

Equation 12. $G_e = Bx \times D_e$ (S)

$$Bx = 2\pi f Cx = \frac{1}{2\pi f Lx}$$

G_e	Relative G accuracy
Dx	Measured D value
Bx	Measured B value
D_e	Relative D accuracy
f	Test frequency (Hz)
Cx	Measured C value (F)
Lx	Measured L value (H)

Rp accuracy (when $Dx \leq 0.1$)

Rp accuracy R_{pe} is given as:

Equation 13. $R_{pe} = \pm \frac{R_{px} \times D_e}{Dx \pm D_e}$ (Ω)

R_{pe}	Relative Rp accuracy
R_{px}	Measured Rp value (Ω)
Dx	Measured D value
D_e	Relative D accuracy

Rs accuracy (when $Dx \leq 0.1$)

Rs accuracy R_{se} is given as:

Equation 14. $R_{se} = Xx \times D_e$ (Ω)

$$Xx = \frac{1}{2\pi f Cx} = 2\pi f Lx$$

R_{se}	Relative Rs accuracy
Dx	Measured D value
Xx	Measured X value (Ω)
D_e	Relative D accuracy
f	Test frequency (Hz)
Cx	Measured C value (F)
Lx	Measured L value (H)

Example of C-D accuracy calculation

Measurement conditions

Test frequency: 1 kHz
Measured C value: 100 nF
Test signal voltage: 1 Vrms
Measurement time mode: Medium
Measurement temperature: 23°C

$$A_b = 0.05\%$$

$$|Z_m| = 1 / (2\pi \times 1 \times 10^3 \times 100 \times 10^{-9}) = 1590 \Omega$$

$$Z_s = 0.6 \text{ m}\Omega \times (1 + 0.400/1) \times (1 + \sqrt{(1000/1000)}) = 1.68 \text{ m}\Omega$$

$$Y_o = 0.5 \text{ nS} \times (1 + 0.100/1) \times (1 + \sqrt{(100/1000)}) = 0.72 \text{ nS}$$

$$C \text{ accuracy: } A_e = [0.05 + 1.68 \text{ m}/1590 \times 100 + 0.72 \text{ n} \times 1590 \times 100] \times 1 = 0.05\%$$

$$D \text{ accuracy: } D_e = 0.05/100 = 0.0005$$

Basic accuracy

Basic accuracy A_b is given from Table 12, 13, 14 and 15.

Test frequency [Hz]	Test signal voltage				
	5 mVrms ≤ - < 50 mVrms	50 mVrms ≤ - < 0.3 Vrms	0.3 Vrms ≤ - ≤ 1 Vrms	1 Vrms < - ≤ 10 Vrms	10 Vrms < - ≤ 20 Vrms
20 ≤ - < 125	(0.6%) × (50 mVrms/Vs)	0.60%	0.30%	0.30%	0.30%
125 ≤ - ≤ 1 M	(0.2%) × (50 mVrms/Vs)	0.20%	0.10%	0.15%	0.15%
1 M < - ≤ 2 M	(0.4%) × (50 mVrms/Vs)	0.40%	0.20%	0.30%	0.30%

Table 12. Measurement time mode = SHORT

Test frequency [Hz]	Test signal voltage				
	5 mVrms ≤ - < 30 mVrms	30 mVrms ≤ - < 0.3 Vrms	0.3 Vrms ≤ - ≤ 1 Vrms	1 Vrms < - ≤ 10 Vrms	10 Vrms < - ≤ 20 Vrms
20 ≤ - < 100	(0.25%) × (30 mVrms/Vs)	0.25%	0.10%	0.15%	0.15%
100 ≤ - ≤ 1 M	(0.1%) × (30 mVrms/Vs)	0.10%	0.05%	0.10%	0.15%
1 M < - ≤ 2 M	(0.2%) × (30 mVrms/Vs)	0.20%	0.10%	0.20%	0.30%

Table 13. Measurement time mode = MED, LONG

Vs [Vrms] Test signal voltage

Effect by impedance of DUT

Test frequency [Hz]	Impedance of DUT	
	1.08 Ω ≤ Zx < 30 Ω	Zx < 1.08 Ω
20 ≤ - ≤ 1 M	0.05%	0.10%
1 M < - ≤ 2 M	0.10%	0.20%

Table 14. For impedance of DUT below 30 Ω, the following value is added.

Test frequency [Hz]	Impedance of DUT	
	9.2 kΩ < Zx ≤ 92 kΩ	92 kΩ < Zx
10 k ≤ - ≤ 100 k	0%	0.05%
100 k < - ≤ 1 M	0.05%	0.05%
1 M < - ≤ 2 M	0.10%	0.10%

Table 15. For impedance of DUT over 9.2 k Ω, the following value is added.

Effect of cable extension

When the cable is extended, the following element is added per one meter.

$$0.015 \% \times (Fm/1 \text{ MHz})^2 \times (L_cable)^2$$

Fm [Hz] Test frequency

L_cable [m] Cable length

Short offset Zs

Test frequency [Hz]	Measurement time mode	
	SHORT	MED, LONG
20 - 2 M	$2.5 \text{ m}\Omega \times (1 + 0.400/V_s) \times (1 + \sqrt{(1000/F_m)})$	$0.6 \text{ m}\Omega \times (1 + 0.400/V_s) \times (1 + \sqrt{(1000/F_m)})$

Table 16. Impedance of DUT > 1.08 Ω

Test frequency [Hz]	Measurement time mode	
	SHORT	MED, LONG
20 - 2 M	$1 \text{ m}\Omega \times (1 + 1/V_s) \times (1 + \sqrt{(1000/F_m)})$	$0.2 \text{ m}\Omega \times (1 + 1/V_s) \times (1 + \sqrt{(1000/F_m)})$

Table 17. Impedance of DUT ≤ 1.08 Ω

Vs [Vrms] Test signal voltage
 Fm [Hz] Test frequency

Effect of cable extension (Short offset)

Test frequency [Hz]	Cable length			
	0 m	1 m	2 m	4 m
20 ≤ - ≤ 1 M	0	0.25 mΩ	0.5 mΩ	1 mΩ
1 M < - ≤ 2 M	0	1 mΩ	2 mΩ	4 mΩ

Table 18. When the cable is extended, the following value is added to Zs (independent of the measurement time mode).

Open offset Y_o

Test frequency [Hz]	Measurement time mode	
	SHORT	MED, LONG
$20 \leq f < 100 \text{ k}$	$2 \text{ nS} \times (1 + 0.100/V_s) \times (1 + \sqrt{(100/F_m)})$	$0.5 \text{ nS} \times (1 + 0.100/V_s) \times (1 + \sqrt{(100/F_m)})$
$100 \text{ k} < f < 1 \text{ M}$	$20 \text{ nS} \times (1 + 0.100/V_s)$	$5 \text{ nS} \times (1 + 0.100/V_s)$
$1 \text{ M} < f < 2 \text{ M}$	$40 \text{ nS} \times (1 + 0.100/V_s)$	$10 \text{ nS} \times (1 + 0.100/V_s)$

Table 19. Test signal voltage $\leq 2.0 \text{ V}_{\text{rms}}$

Test frequency [Hz]	Measurement time mode	
	SHORT	MED, LONG
$20 \leq f < 100 \text{ k}$	$2 \text{ nS} \times (1 + 2/V_s) \times (1 + \sqrt{(100/F_m)})$	$0.5 \text{ nS} \times (1 + 2/V_s) \times (1 + \sqrt{(100/F_m)})$
$100 \text{ k} < f < 1 \text{ M}$	$20 \text{ nS} \times (1 + 2/V_s)$	$5 \text{ nS} \times (1 + 2/V_s)$
$1 \text{ M} < f < 2 \text{ M}$	$40 \text{ nS} \times (1 + 2/V_s)$	$10 \text{ nS} \times (1 + 2/V_s)$

Table 20. Test signal voltage $> 2.0 \text{ V}_{\text{rms}}$

V_s [V_{rms}] Test signal voltage
 F_m [Hz] Test frequency

Note

The Open Offset may become three times greater in the ranges of 40 to 70 kHz and 80 to 100 kHz due to residual response.

Effect of cable length

Test frequency [Hz]	Cable length			
	0 m	1 m	2 m	4 m
$100 \leq f < 100 \text{ k}$	1	$1 + 5 \times F_m/1 \text{ MHz}$	$1 + 10 \times F_m/1 \text{ MHz}$	$1 + 20 \times F_m/1 \text{ MHz}$
$100 \text{ k} \leq f < 1 \text{ M}$	1	$1 + 0.5 \times F_m/1 \text{ MHz}$	$1 + 1 \times F_m/1 \text{ MHz}$	$1 + 2 \times F_m/1 \text{ MHz}$
$1 \text{ M} < f < 2 \text{ M}$	1	$1 + 1 \times F_m/1 \text{ MHz}$	$1 + 2 \times F_m/1 \text{ MHz}$	$1 + 4 \times F_m/1 \text{ MHz}$

Table 21. When the cable is extended, multiply Y_o by the following factor.

F_m [Hz] Test frequency

Temperature factor Kt

Temperature [°C]	Kt
$0 \leq - < 18$	4
$18 \leq - \leq 28$	1
$28 < - \leq 55$	4

Table 22. The temperature factor Kt is given below.

Calibration accuracy Acal

Calibration accuracy Acal is given below.

For impedance of DUT or test frequency on the boundary line, apply the smaller value.

	Test frequency [Hz]					
	20 - 1 k	1 k - 10 k	10 k - 100 k	100 k - 300 k	300 k - 1 M	1 M - 2 M
Z [%]	0.03	0.05	0.05	$0.05 + 5 \times 10^{-5} F_m$	$0.05 + 5 \times 10^{-5} F_m$	$0.1 + 1 \times 10^{-4} F_m$
θ [radian]	1×10^{-4}	2×10^{-4}	3×10^{-4}	$3 \times 10^{-4} + 2 \times 10^{-7} F_m$	$3 \times 10^{-4} + 2 \times 10^{-7} F_m$	$6 \times 10^{-4} + 4 \times 10^{-7} F_m$

Table 23. Impedance range = 0.1, 1, 10 Ω

	Test frequency [Hz]					
	20 - 1 k	1 k - 10 k	10 k - 100 k	100 k - 300 k	300 k - 1 M	1 M - 2 M
Z [%]	0.03	0.05	0.05	$0.05 + 5 \times 10^{-5} F_m$	$0.05 + 5 \times 10^{-5} F_m$	$0.1 + 1 \times 10^{-4} F_m$
θ [radian]	1×10^{-4}	2×10^{-4}	3×10^{-4}	3×10^{-4}	3×10^{-4}	6×10^{-4}

Table 24. Impedance range = 100 Ω

	Test frequency [Hz]					
	20 - 1 k	1 k - 10 k	10 k -100 k	100 k - 300 k	300 k - 1 M	1 M - 2 M
Z [%]	0.03	0.03	0.05	0.05	0.05	0.1
θ [radian]	1×10^{-4}	1×10^{-4}	3×10^{-4}	3×10^{-4}	3×10^{-4}	6×10^{-4}

Table 25. Impedance range = 300, 1 k Ω

	Test frequency [Hz]					
	20 - 1 k	1 k - 10 k	10 k -100 k	100 k - 300 k	300 k - 1 M	1 M - 2 M
Z [%]	$0.03 + 1 \times 10^{-4} F_m$	$0.03 + 1 \times 10^{-4} F_m$	$0.03 + 1 \times 10^{-4} F_m$	$0.03 + 1 \times 10^{-4} F_m$	$0.03 + 1 \times 10^{-4} F_m$	$0.06 + 2 \times 10^{-4} F_m$
θ [radian]	$(100 + 2.5 F_m) \times 10^{-6}$	$(100 + 2.5 F_m) \times 10^{-6}$	$(100 + 2.5 F_m) \times 10^{-6}$	$(100 + 2.5 F_m) \times 10^{-6}$	$(100 + 2.5 F_m) \times 10^{-6}$	$(200 + 5 F_m) \times 10^{-6}$

Table 26. Impedance range = 3 k, 10 k Ω

	Test frequency [Hz]					
	20 - 1 k	1 k - 10 k	10 k -100 k	100 k - 300 k	300 k - 1 M	1 M - 2 M
Z [%]	$0.03 + 1 \times 10^{-3} F_m$	$0.03 + 1 \times 10^{-3} F_m$	$0.03 + 1 \times 10^{-3} F_m$	$0.03 + 1 \times 10^{-3} F_m$	$0.03 + 1 \times 10^{-4} F_m$	$0.06 + 2 \times 10^{-4} F_m$
θ [radian]	$(100 + 20 F_m) \times 10^{-6}$	$(100 + 20 F_m) \times 10^{-6}$	$(100 + 20 F_m) \times 10^{-6}$	$(100 + 20 F_m) \times 10^{-6}$	$(100 + 2.5 F_m) \times 10^{-6}$	$(200 + 5 F_m) \times 10^{-6}$

Table 27. Impedance range = 30 k, 100 k Ω

Fm[kHz] Test frequency

Measurement accuracy

The impedance measurement calculation example below is the result of absolute measurement accuracy.

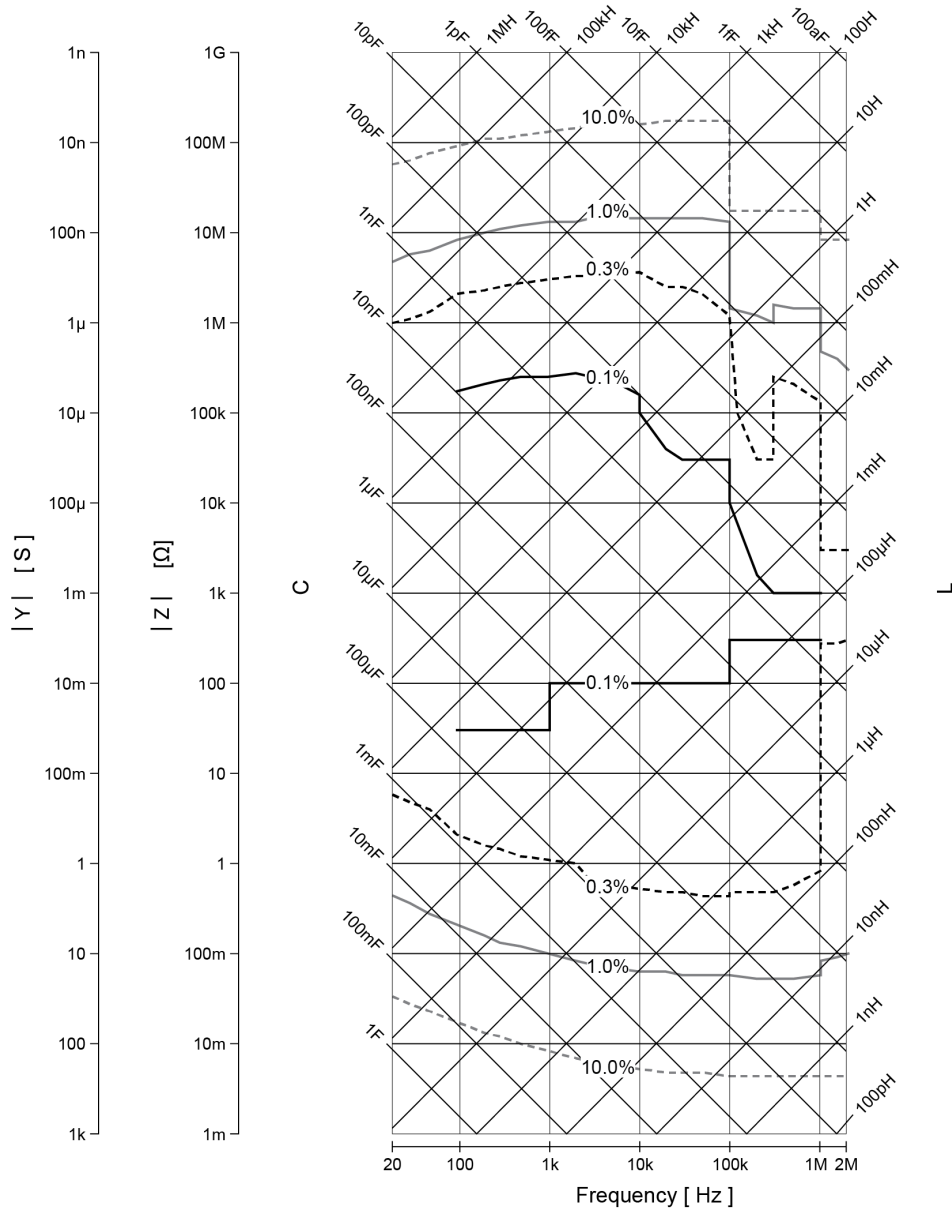

Figure 1. Impedance measurement accuracy (Test signal voltage = 1 Vrms, cable length = 0 m, measurement time mode = MED)

Compensation function

Type of compensation	Description
OPEN compensation	Compensates errors caused by the stray admittance (C, G) of the test fixture.
SHORT compensation	Compensates errors caused by the residual impedance (L, R) of the test fixture.
LOAD compensation	Compensates errors between the actual measured value and a known standard value under the measurement conditions desired by the user.

Table 28. The E4980A provides three types of compensation functions: OPEN compensation, SHORT compensation, and LOAD compensation.

List sweep

Points: There is a maximum of 201 points.

First sweep parameter (primary parameter): Test frequency, test signal voltage, test signal current, test signal voltage of DC bias signal, test signal current of DC bias signal, DC source voltage.

Second sweep parameter (secondary parameter): None, impedance range, test frequency, test signal voltage, test signal current, test signal voltage of DC bias signal, test signal current of DC bias signal, DC source voltage

Note

A parameter selected for one of the two parameters cannot be selected for the other parameter. It is not possible to set up a combination of test signal voltage and test signal current or one of test signal voltage of DC bias signal and test signal current of DC bias.

The secondary parameter can be set only with SCPI commands.

Trigger mode

Sequential mode: When the E4980A is triggered once, the device is measured at all sweep points. /EOM/INDEX is output only once.

Step mode: The sweep point is incremented each time the E4980A is triggered. /EOM/INDEX is output at each point, but the result of the comparator function of the list sweep is available only after the last /EOM is output.

Comparator function of list sweep: The comparator function enables setting one pair of lower and upper limits for each measurement point.

You can select from: Judge with the first sweep parameter/Judge with the second parameter/Not used for each pair of limits.

Time stamp function: In the sequential mode, it is possible to record the measurement starting time at each measurement point by defining the time when FW detects a trigger as 0 and obtain it later with the SCPI command.

Comparator function

Bin sort: The primary parameter can be sorted into 9 BINS, OUT_OF_BINS, AUX_BIN, and LOW_C_REJECT. The secondary parameter can be sorted into HIGH, IN, and LOW. The sequential mode and tolerance mode can be selected as the sorting mode.

Limit setup: Absolute value, deviation value, and % deviation value can be used for setup.

BIN count: Countable from 0 to 999999.

DC bias signal

Range	0 V to +2 V
Resolution	0 V / 1.5 V / 2 V only
Accuracy	0.1% + 2 mV (23°C ± 5°C) (0.1% + 2 mV) × 4 (0 to 18°C or 28 to 55°C)

Table 29. Test signal voltage

Output impedance: 100 Ω (nominal)

Measurement assistance functions

Data buffer function: Up to 201 measurement results can be read out in a batch.

Save/Recall function:

- Up to 10 setup conditions can be written to/read from the built-in non-volatile memory.
- Up to 10 setup conditions can be written to/read from the USB memory.
- Auto recall function can be performed when the setting conditions are written to Register 10 of the USB memory.

Key lock function: The front panel keys can be locked.

GPIB: 24-pin D-Sub (Type D-24), female; complies with IEEE488.1, 2 and SCPI

USB host port: Universal serial bus jack, type-A (4 contact positions, contact 1 is on your left), female (for connection to USB memory only).

USB interface port: Universal serial bus jack, type mini-B (4 contact positions); complies with USBTMC-USB488 and USB 2.0; female; for connection to the external controller.

USBTMC: Abbreviation for USB Test & Measurement Class

LAN: 10/100 BaseT Ethernet, 8 pins (two speed options)

LXI Compliance: Class C (only applies to units with firmware revision A.02.00 or later)

Note

This note is for the E4980A/E4980AL units with firmware A.xx.xx.

The following USB memory can be used.

Complies with USB 1.1; mass storage class, FAT16/FAT32 format; maximum consumption current is below 500 mA.

Recommended USB memory: 4 GB USB Flash memory (Keysight PN 1819-0637) and 16GB USB Flash memory (Keysight PN 1819-1235).

Use the recommended USB memory device exclusively for the E4980A/E4980AL, otherwise, previously saved data may be cleared.

If you use a USB memory other than the recommended device, data may not be saved or recalled normally.

Keysight will NOT be responsible for data loss in the USB memory caused by using the E4980A/E4980AL.

Options

Frequency options

E4980A	20 Hz to 2 MHz
E4980AL-032	20 Hz to 300 kHz
E4980AL-052	20 Hz to 500 kHz
E4980AL-102	20 Hz to 1 MHz

Note

Option xxx is described as E4980A-xxx in the order information

Options	E4980A	E4980AL
Power and DC bias enhancement (001)	Installable	Not installable
DCR measurement (200)	Installable ¹	Not installable ²
Handler interface (201)	Installable	Installable
Scanner interface (301)	Installable	Installable

1. Mandatory option

2. DCR measurement function is equipped by default.

Table 30. Installable options

Interface options

Option 201 (Handler interface)

Adds handler interface.

Option 301 (Scanner interface)

Adds scanner interface.

Option 710 (No interface)

An option with no interface.

Up to 2 interface options can be installed in the interface connector on the rear panel.

When no interface is installed, two of the option 710 are installed. When one interface is installed, the option number of its interface and one option 710 are installed.

Other options

Option 001 (Power and DC Bias enhancement)

Increases test signal voltage and adds the variable DC bias voltage.

Option 007 (Standard model)

Upgrades the entry model to the standard (only available in E4980AU).

Note

Option 007 can be installed only in the E4980A with option 005.

Option 200 (DCR measurement)

Adds DCR measurement

Note

E4980A-200/001 and E4980AL-032/052/102 supports DCR measurement function.

Power and DC bias enhancement specification

Increases test signal voltage and adds the variable DC bias voltage function. The Vdc-Idc measurement function is available when the option 001 is installed.

Measurement parameters

The following parameters can be used.

- Lp-Rdc
- Ls-Rdc
- Vdc-Idc

where

Rdc Direct-current resistance (DCR)

Vdc Direct-current voltage

Idc Direct-current electricity

Test signal

Signal level

Range		0 Vrms to 20 Vrms (test frequency \leq 1 MHz) 0 Vrms to 15 Vrms (test frequency $>$ 1 MHz)
Resolution		100 μ Vrms (0 Vrms \leq - \leq 0.2 Vrms) 200 μ Vrms (0.2 Vrms $<$ - \leq 0.5 Vrms) 500 μ Vrms (0.5 Vrms $<$ - \leq 1 Vrms) 1 mVrms (1 Vrms $<$ - \leq 2 Vrms) 2 mVrms (2 Vrms $<$ - \leq 5 Vrms) 5 mVrms (5 Vrms $<$ - \leq 10 Vrms) 10 mVrms (10 Vrms $<$ - \leq 20 Vrms)
Setup accuracy	Normal	$\pm(10\% + 1 \text{ mVrms})$ (test signal voltage \leq 2 Vrms) (test frequency \leq 1 MHz : spec., test frequency $>$ 1 MHz : typ.)
		$\pm(10\% + 10 \text{ mVrms})$ (Test frequency \leq 300 kHz, test signal voltage $>$ 2 Vrms) (spec.)
		$\pm(15\% + 20 \text{ mVrms})$ (test frequency $>$ 300 kHz, test signal voltage $>$ 2 Vrms) (test frequency \leq 1 MHz : spec., test frequency $>$ 1 MHz : typ.)
	Constant ¹	$\pm(6\% + 1 \text{ mVrms})$ (test signal voltage \leq 2 Vrms) (test frequency \leq 1 MHz : spec., test frequency $>$ 1 MHz : typ.)
		$\pm(6\% + 10 \text{ mVrms})$ (test frequency \leq 300 kHz, test signal voltage $>$ 2 Vrms) (spec.)
		$\pm(12\% + 20 \text{ mVrms})$ (test frequency $>$ 300 kHz, test signal voltage $>$ 2 Vrms) (test frequency \leq 1 MHz : spec., test frequency $>$ 1 MHz : typ.)

1. When auto level control function is on.

Table 31. Test signal voltage

Range		0 Arms - 100 mArms
Resolution		1 μ Arms (0 Arms \leq - \leq 2 mArms) 2 μ Arms (2 mArms $<$ - \leq 5 mArms) 5 μ Arms (5 mArms $<$ - \leq 10 mArms) 10 μ Arms (10 mArms $<$ - \leq 20 mArms) 20 μ Arms (20 mArms $<$ - \leq 50 mArms) 50 μ Arms (50 mArms $<$ - \leq 100 mArms)
Setup accuracy	Normal	$\pm(10\% + 10 \mu\text{Arms})$ (test signal voltage \leq 20 mArms) (test frequency \leq 1 MHz : spec., test frequency $>$ 1 MHz : typ.)
		$\pm(10\% + 100 \mu\text{Arms})$ (test frequency \leq 300 kHz, test signal current $>$ 20 mArms) (spec.)

	$\pm(15\% + 200 \mu\text{Arms})$ (test frequency > 300 kHz, test signal voltage > 20 mArms) (test frequency \leq 1 MHz : spec., test frequency > 1 MHz : typ.)
Constant ¹	$\pm(6\% + 10 \mu\text{Arms})$ (test signal voltage \leq 20 mArms) (test frequency \leq 1 MHz : spec., test frequency > 1 MHz : typ.)
	$\pm(6\% + 100 \mu\text{Arms})$ (test frequency \leq 300 kHz, test signal voltage > 20 mArms) (spec.)
	$\pm(12\% + 200 \mu\text{Arms})$ (test frequency > 300 kHz, test signal voltage > 20 mArms) (test frequency \leq 1 MHz : spec., test frequency > 1 MHz : typ.)

Table 32. Test signal current

Test signal level monitor function

- Test signal voltage and test signal current can be monitored.
- Level monitor accuracy:

Test signal voltage ²	Test frequency	Specification
5 mVrms to 2 Vrms	\leq 1 MHz	$\pm(3\%$ of reading value + 0.5 mVrms)
	> 1MHz	$\pm(6\%$ of reading value + 1 mVrms)
> 2 Vrms	\leq 300 kHz	$\pm(3\%$ of reading value + 5 mVrms)
	> 300 kHz	$\pm(6\%$ of reading value + 10 mVrms) ³

Table 33. Test signal voltage monitor accuracy (Vac)

Test signal current ²	Test frequency	Specification
50 μ Arms to 20 mArms	\leq 1 MHz	$\pm(3\%$ of reading value + 5 μ Arms)
	> 1MHz	$\pm(6\%$ of reading value + 10 μ Arms)
> 20 mArms	\leq 300 kHz	$\pm(3\%$ of reading value + 50 μ Arms)
	> 300 kHz	$\pm(6\%$ of reading value + 100 μ Arms)

Table 34. Test signal current monitor accuracy (Iac)

1. When auto level control function is on.
2. This is not an output value but a displayed test signal level
3. Typ. when test frequency is > 1 MHz with test signal voltage > 10 Vrms.

DC bias signal

Range	-40 V to +40 V	
Resolution	Setup resolution: 100 μ V, effective resolution: 330 μ V \pm (0 V \leq - \leq 5 V) 1 mV \pm (5 V < - \leq 10 V) 2 mV \pm (10 V < - \leq 20 V) 5 mV \pm (20 V < - \leq 40 V)	
Accuracy	test signal voltage \leq 2 Vrms	0.1% + 2 mV (23°C \pm 5°C) (0.1% + 2 mV) \times 4 (0 to 18°C or 28 to 55°C)
	test signal voltage > 2 Vrms	0.1 % + 4 mV (23°C \pm 5°C) (0.1% + 4 mV) \times 4 (0 to 18°C or 28 to 55°C)

Table 35. Test signal voltage

Range	-100 mA - 100 mA	
Resolution	Setup resolution: 1 μ A, effective resolution: 3.3 μ A \pm (0 A \leq - \leq 50 mA) 10 μ A \pm (50 mA < - \leq 100 mA)	

Table 36. Test signal current

DC bias voltage level monitor Vdc

$$(0.5\% \text{ of reading value} + 60 \text{ mV}) \times Kt$$

When using Vdc-Idc measurement: (spec.)

When using level monitor: (typ.)

Kt Temperature coefficient

DC bias current level monitor Idc

$$(A [\%] \text{ of the measurement value} + B [A]) \times Kt$$

When using Vdc-Idc measurement: (spec.)

When using level monitor: (typ.)

A [%] When the measurement time mode is SHORT: 2%
 When the measurement time mode is MED or LONG: 1%

B [A] given below

Kt Temperature coefficient

When the measurement mode is SHORT, double the following value.

DC bias current range	Impedance range [Ω]				
	< 100	100	300, 1 k	3 k, 10 k	30k, 100 k
20 μ A	150 μ A	30 μ A	3 μ A	300 nA	45 nA
200 μ A	150 μ A	30 μ A	3 μ A	300 nA	300 nA
2 mA	150 μ A	30 μ A	3 μ A	3 μ A	3 μ A
20 mA	150 μ A	30 μ A	30 μ A	30 μ A	30 μ A
100 mA	150 μ A	150 μ A	150 μ A	150 μ A	150 μ A

Table 37. Test signal voltage ≤ 0.2 Vrms (measurement time mode = MED, LONG)

DC bias current range	Impedance range [Ω]				
	< 100	100, 300	1k, 3 k	10k, 30 k	100 k
20 μ A	150 μ A	30 μ A	3 μ A	300 nA	45 nA
200 μ A	150 μ A	30 μ A	3 μ A	300 nA	300 nA
2 mA	150 μ A	30 μ A	3 μ A	3 μ A	3 μ A
20 mA	150 μ A	30 μ A	30 μ A	30 μ A	30 μ A
100 mA	150 μ A	150 μ A	150 μ A	150 μ A	150 μ A

Table 38. 0.2 Vrms < test signal voltage ≤ 2 Vrms (measurement time mode = MED, LONG)

DC bias current range	Impedance range [Ω]			
	≤ 300	1 k, 3 k	10k, 30 k	100 k
20 μ A	150 μ A	30 μ A	3 μ A	300 nA
200 μ A	150 μ A	30 μ A	3 μ A	300 nA
2 mA	150 μ A	30 μ A	3 μ A	3 μ A
20 mA	150 μ A	30 μ A	30 μ A	30 μ A
100 mA	150 μ A	150 μ A	150 μ A	150 μ A

Table 39. Test signal voltage > 2 Vrms (measurement time mode = MED, LONG)

Input impedance	Conditions
0 Ω	Other than conditions below.
20 Ω	Test signal voltage ≤ 0.2 Vrms, Impedance range ≥ 3 k Ω , DC bias current range ≤ 200 μ A
	Test signal voltage ≤ 2 Vrms, Impedance range ≥ 10 k Ω , DC bias current range ≤ 200 μ A
	Test signal voltage > 2 Vrms, Impedance range = 100 k Ω , DC bias current range ≤ 200 μ A

Table 40. Input impedance (nominal)

DC source signal

Range	-10 V to 10 V
Resolution	1 mV
Accuracy	0.1% + 3 mV (23°C \pm 5°C) (0.1% + 3 mV) x 4 (0 to 18°C or 28 to 55°C)

Table 41. Test signal voltage

Range	-45 mA to 45 mA (nominal)
-------	---------------------------

Table 42. Test signal current

Output impedance: 100 Ω (nominal)

DCR measurement specification

DC resistance (Rdc) measurement function is available when either E4980A-001/200 or E4980AL-032/052/102 is installed.

DC resistance (Rdc) accuracy

Absolute measurement accuracy Aa

Absolute measurement accuracy Aa is given as

Equation 15. $Aa = Ae + Acal$

- Aa Absolute accuracy (% of reading value)
- Ae Relative accuracy (% of reading value)
- Acal Calibration accuracy

Relative measurement accuracy Ae

Relative measurement accuracy Ae is given as

Equation 16. $Ae = [Ab + (Rs / |Rm| + Go \times |Rm|) \times 100] \times Kt$

- Rm Measurement value
- Ab Basic accuracy
- Rs Short offset [Ω]
- Go Open offset [S]
- Kt Temperature coefficient

Calibration accuracy Acal

Calibration accuracy Acal is 0.03%.

Basic accuracy Ab

Measurement time mode	Test signal voltage	
	$\leq 2 V_{rms}$	$> 2 V_{rms}$
SHORT	1.00%	2.00%
MED	0.30%	0.60%

Table 43. Basic accuracy Ab is given below.

Open offset Go

Measurement time mode	Test signal voltage	
	$\leq 2 V_{rms}$	$> 2 V_{rms}$
SHORT	50 nS	500 nS
MED	10 nS	100 nS

Table 44. Open offset Go is given below.

Short offset Rs

Measurement time mode	Test signal voltage	
	$\leq 2 \text{ Vrms}$	$> 2 \text{ Vrms}$
SHORT	25 m Ω	250 m Ω
MED	5 m Ω	50 m Ω

Table 45. Short offset Rs is given below.

Effect of cable length (Short offset)

Cable length		
1 m	2 m	4 m
0.25 m Ω	0.5 m Ω	1 m Ω

Table 46. The following value is added to Rs when the cable is extended.

Temperature coefficient Kt

Temperature [°C]	Kt
$0 \leq - < 18$	4
$18 \leq - \leq 28$	1
$28 < - \leq 55$	4

Table 47. Temperature coefficient Kt is given below.

General Specifications

Voltage	90 VAC - 264 VAC
Frequency	47 Hz - 63 Hz
Power consumption	Max. 150 VA

Table 48. Power source

Temperature	0 - 55°C
Humidity ($\leq 40^\circ\text{C}$, no condensation)	15% - 85% RH
Altitude	0 m - 2000 m

Table 49. Operating environment

Temperature	-20 - 70°C
Humidity ($\leq 60^\circ\text{C}$, no condensation)	0% - 90% RH
Altitude	0 m - 4572 m

Table 50. Storage environment

Outer dimensions: 375 (width) x 105 (height) x 390 (depth) mm (nominal)

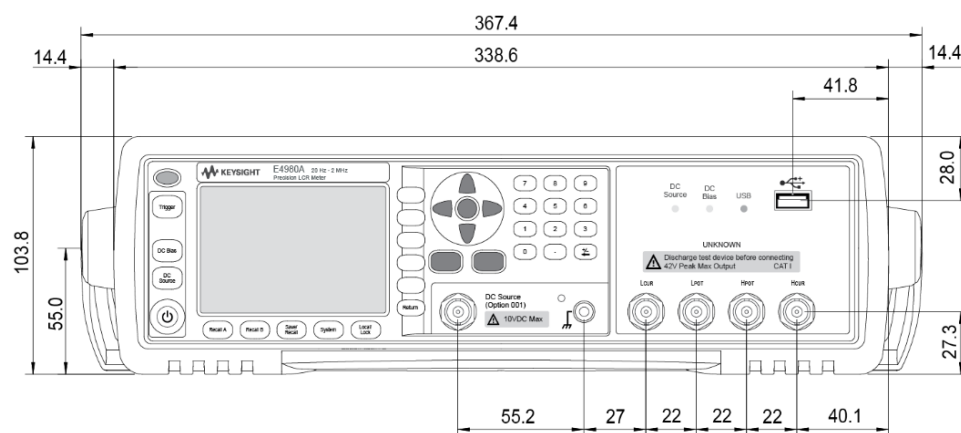

Figure 2. Dimensions (front view, with handle and bumper, in millimeters, nominal)

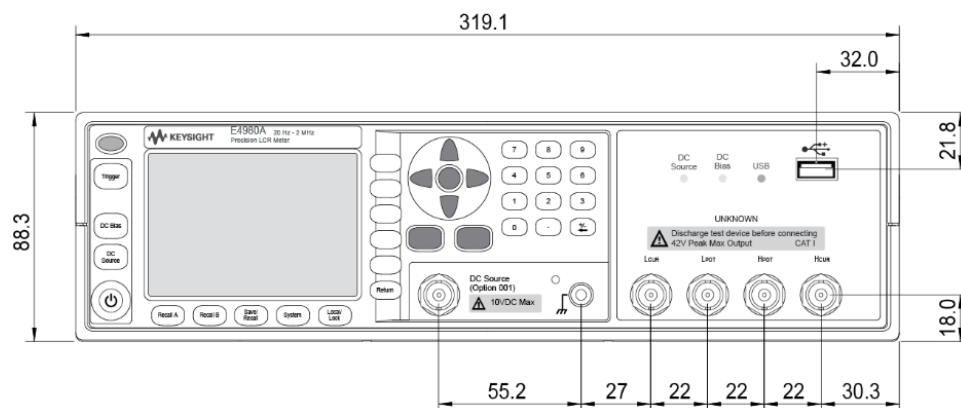

Figure 3. Dimensions (front view, without handle and bumper, in millimeters, nominal)

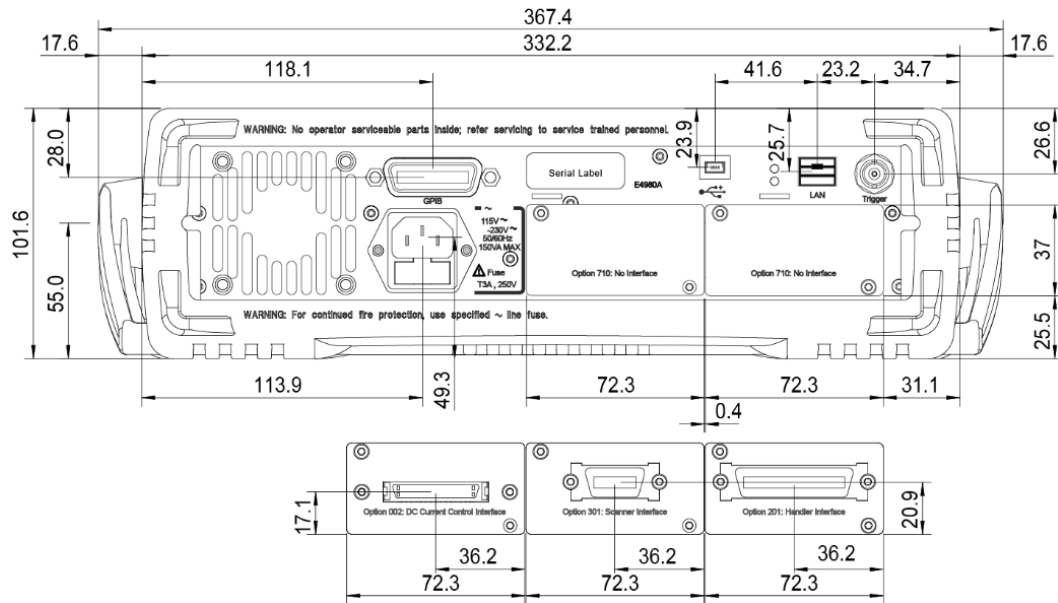

Figure 4. Dimensions (rear view, with handle and bumper, in millimeters, nominal)

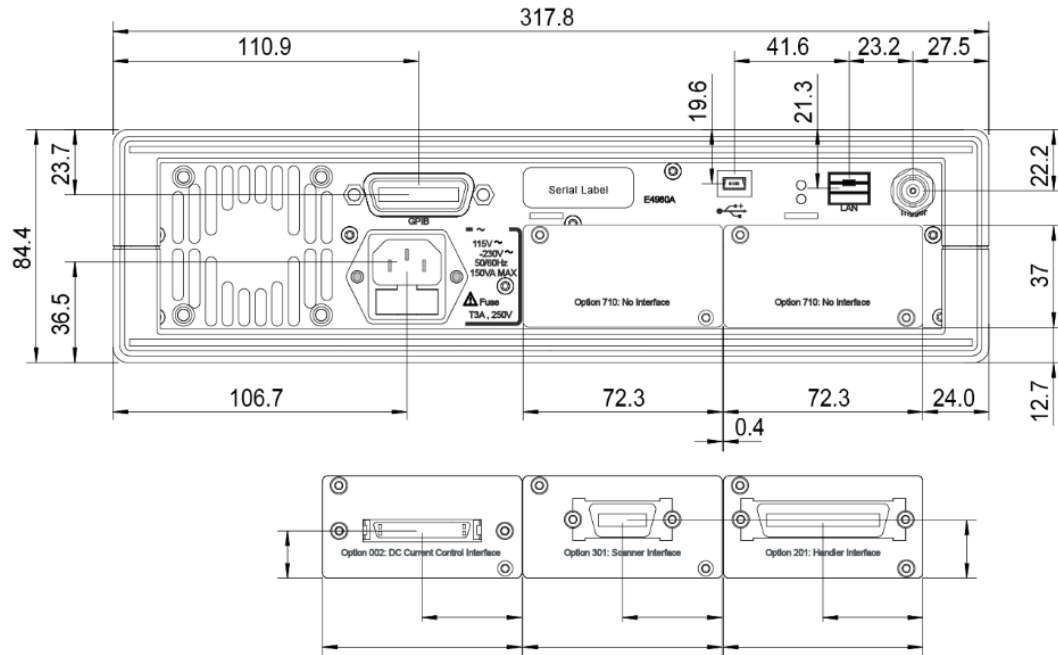

Figure 5. Dimensions (rear view, with handle and bumper, in millimeters, nominal)

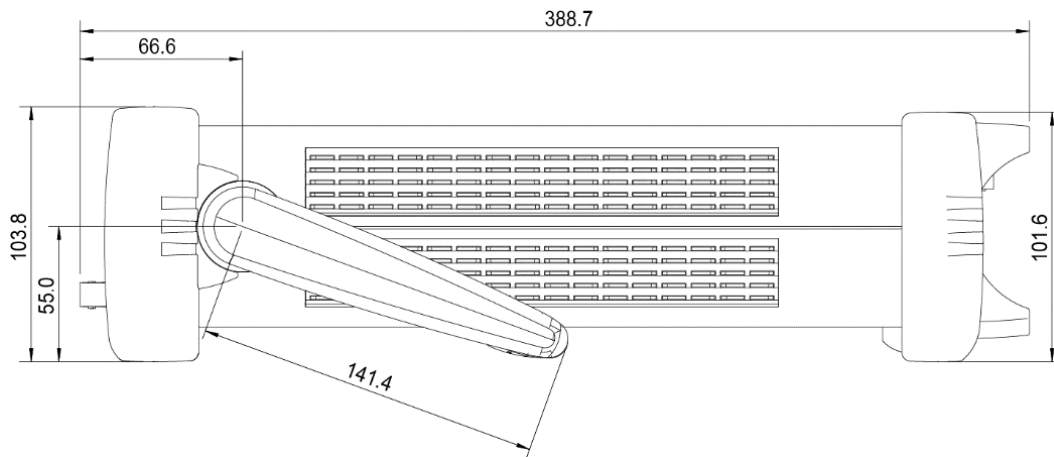

Figure 6. Dimensions (side view, with handle and bumper, in millimeters, nominal)

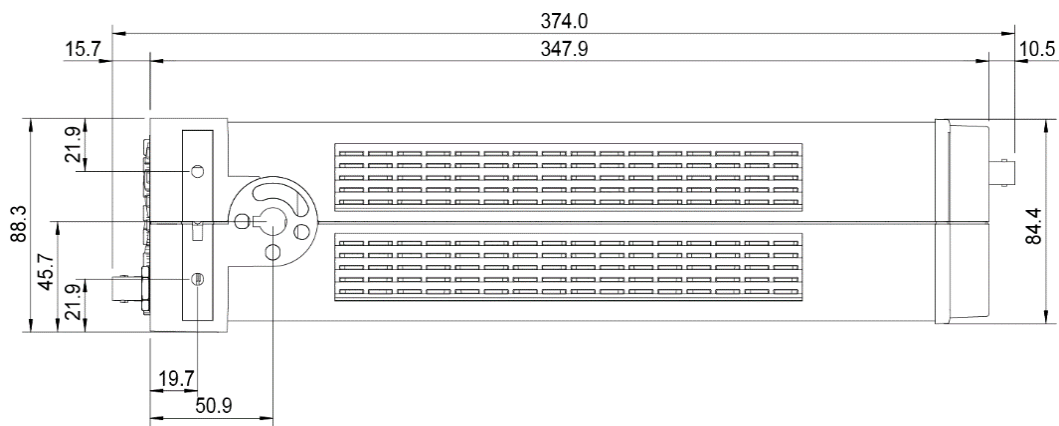

Figure 7. Dimensions (side view, without handle and bumper, in millimeters, nominal)

Weight: 5.3 kg (nominal)



Display: LCD, 320 × 240 (pixels), RGB color

Note

Effective pixels are more than 99.99%. There may be 0.01% (approx. 7 pixels) or smaller missing pixels or constantly lit pixels, but this is not a malfunction.

The following items can be displayed:

- Measurement value
- Measurement conditions
- Limit value and judgment result of comparator
- List sweep table
- Self-test message

Description	Supplemental Information
EMC	
	<p>European Council Directive 2004/108/EC IEC 61326-1:2012 EN 61326-1:2013 CISPR 11:2009 +A1:2010 EN 55011: 2009 +A1:2010 Group 1, Class A IEC 61000-4-2:2008 EN 61000-4-2:2009 4 kV CD / 8 kV AD IEC 61000-4-3:2006 +A1:2007 +A2:2010 EN 61000-4-3:2006 +A1:2008 +A2:2010 3 V/m, 80-1000 MHz, 1.4 - 2.0 GHz / 1V/m, 2.0 - 2.7 GHz, 80% AM IEC 61000-4-4:2004 +A1:2010 EN 61000-4-4:2004 +A1:2010 1 kV power lines / 0.5 kV signal lines IEC 61000-4-5:2005 EN 61000-4-5:2006 0.5 kV line-line / 1 kV line-ground IEC 61000-4-6:2008 EN 61000-4-6:2009 3 V, 0.15-80 MHz, 80% AM IEC 61000-4-8:2009 EN 61000-4-8:2010 30A/m, 50/60Hz IEC 61000-4-11:2004 EN 61000-4-11:2004 0.5-300 cycle, 0% / 70%</p> <p>Note: When tested at 3 V/m according to EN61000-4-3, the measurement accuracy will be within specifications over the full immunity test frequency range except when the meter frequency is identical to the transmitted interference signal test frequency (the frequencies around the carrier frequency and frequencies around the modulation frequency).</p>
ICES/NMB-001	ICES-001:2006 Group 1, Class A
	AS/NZS CISPR11:2004 Group 1, Class A
	KN11, KN61000-6-1 and KN61000-6-2 Group 1, Class A

Safety



European Council Directive 2006/95/EC
IEC 61010-1:2001/EN 61010-1:2001
Measurement Category I, Pollution Degree 2, Indoor Use
IEC60825-1:1994 Class 1 LED



CAN/CSA C22.2 61010-1-04
Measurement Category I, Pollution Degree 2, Indoor Use

Environment

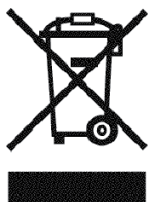

This product complies with the WEEE Directive (2002/96/EC) marking requirements. The affixed label indicates that you must not discard this electrical/electronic product in domestic household waste.

Product Category: With reference to the equipment types in the WEEE Directive Annex I, this product is classed as a "Monitoring and Control instrumentation" product.

Supplemental Information

Settling time

Test frequency setting time	Test frequency (Fm)
5 ms	$F_m \geq 1 \text{ kHz}$
12 ms	$1 \text{ kHz} > F_m \geq 250 \text{ Hz}$
22 ms	$250 \text{ Hz} > F_m \geq 60 \text{ Hz}$
42 ms	$60 \text{ Hz} > F_m$

Table 51. Test frequency setting time

Test signal voltage setting time	Test frequency (Fm)
11 ms	$F_m \geq 1 \text{ kHz}$
18 ms	$1 \text{ kHz} > F_m \geq 250 \text{ Hz}$
26 ms	$250 \text{ Hz} > F_m \geq 60 \text{ Hz}$
48 ms	$60 \text{ Hz} > F_m$

Table 52. Test signal voltage setting time

Switching of the impedance range is as follows:
 ≤ 5 ms/ range switching

Measurement circuit protection

The maximum discharge withstand voltage, where the internal circuit remains protected if a charged capacitor is connected to the UNKNOWN terminal, is given below.

Maximum discharge withstand voltage	Range of capacitance value C of DUT
1000 V	$C < 2 \mu\text{F}$
$\sqrt{2/C}$ V	$2 \mu\text{F} \leq C$

Note
 Discharge capacitors before connecting them to the UNKNOWN terminal or a test fixture to avoid damages to the instrument.

Table 53. Maximum discharge withstand voltage

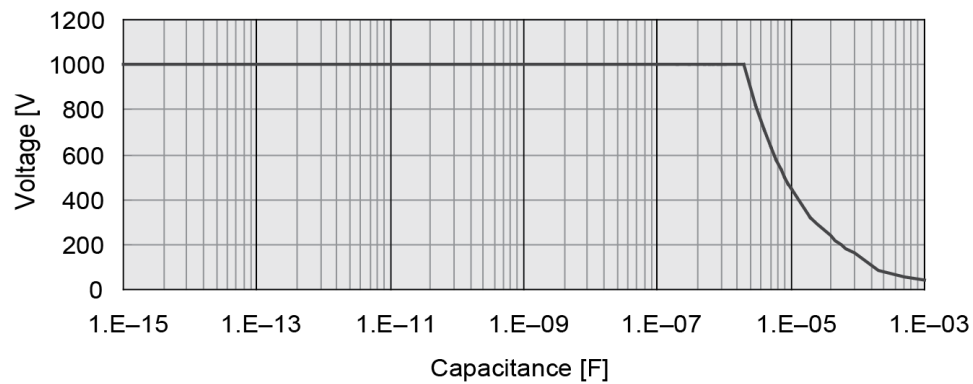

Figure 8. Maximum discharge withstand voltage

Measurement time

Definition

This is the time between the trigger and the end of measurement (EOM) output on the handler interface.

Conditions

Table 54, 55 and 56 show the measurement time when the following conditions are satisfied:

- Normal impedance measurement other than Ls-Rdc, Lp-Rdc, Vdc-Idc
- Impedance range mode: hold range mode
- DC bias voltage level monitor: OFF
- DC bias current level monitor: OFF
- Trigger delay: 0 s
- Step delay: 0 s
- Calibration data: OFF
- Display mode: blank

	Measurement time mode	Test frequency						
		20 Hz	100 Hz	1 kHz	10 kHz	100 kHz	1 MHz	2 MHz
1	LONG	480	300	240	230	220	220	220
2	MED	380	180	110	92	89	88	88
3	SHORT	330	100	20	7.7	5.7	5.6	5.6

Table 54. E4980A measurement time [ms](DC bias:OFF)

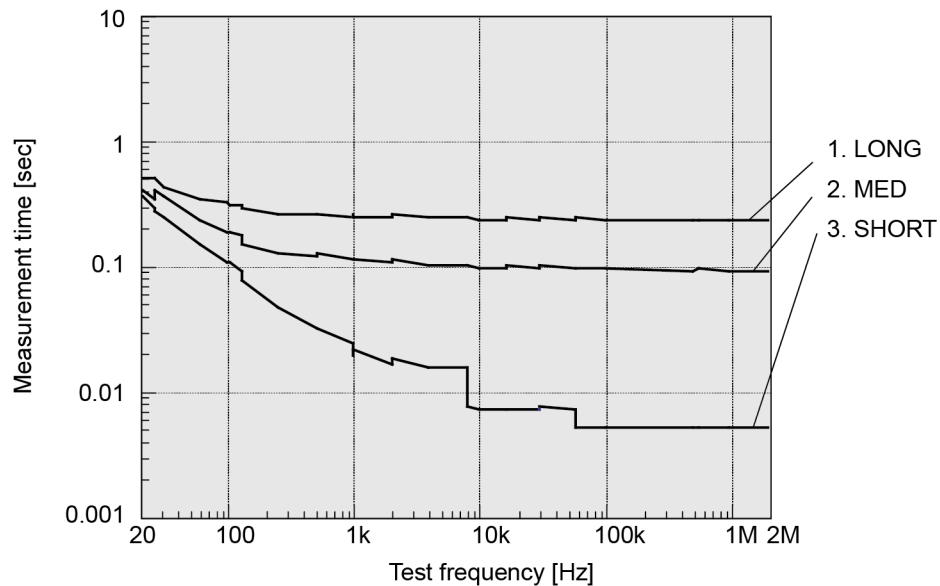

Figure 9. Measurement time (E4980A, DC bias: OFF)

	Measurement time mode	Test frequency						
		20 Hz	100 Hz	1 kHz	10 kHz	100 kHz	1 MHz	2 MHz
1	LONG	1190	650	590	580	570	570	570
2	MED	1150	380	200	180	180	180	180
3	SHORT	1040	240	37	25	23	23	23

Note
E4980A-005 is obsolete and not available in a new purchase.

Table 55. E4980A-005 measurement time [ms] (DC bias: OFF)

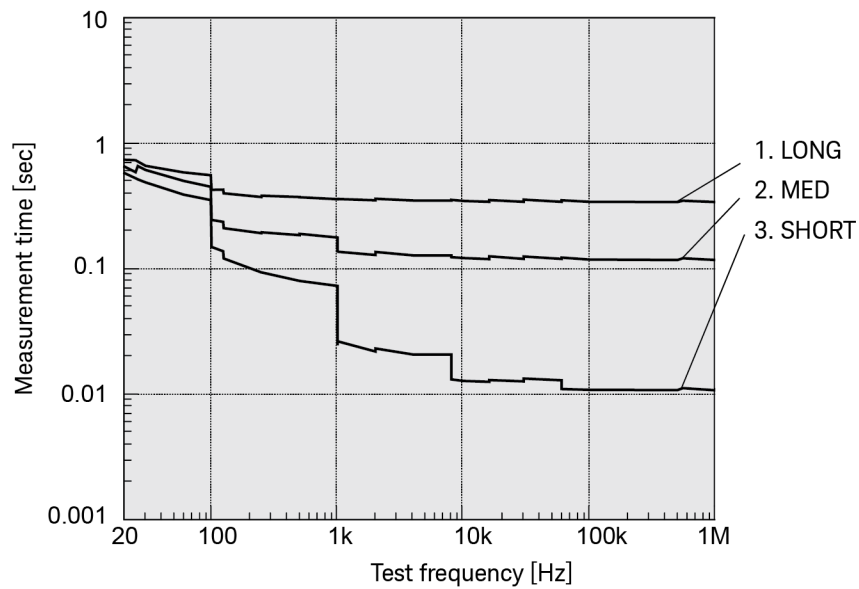

Figure 10. Measurement time (DC bias: OFF, E4980A-005)

	Measurement time mode	Test frequency					
		20 Hz	100 Hz	1 kHz	10 kHz	100 kHz	1 MHz
1	LONG	729	423	363	353	343	343
2	MED	650	250	140	122	119	118
3	SHORT	579	149	26	14	12	12

Table 56. E4980AL measurement time [ms]

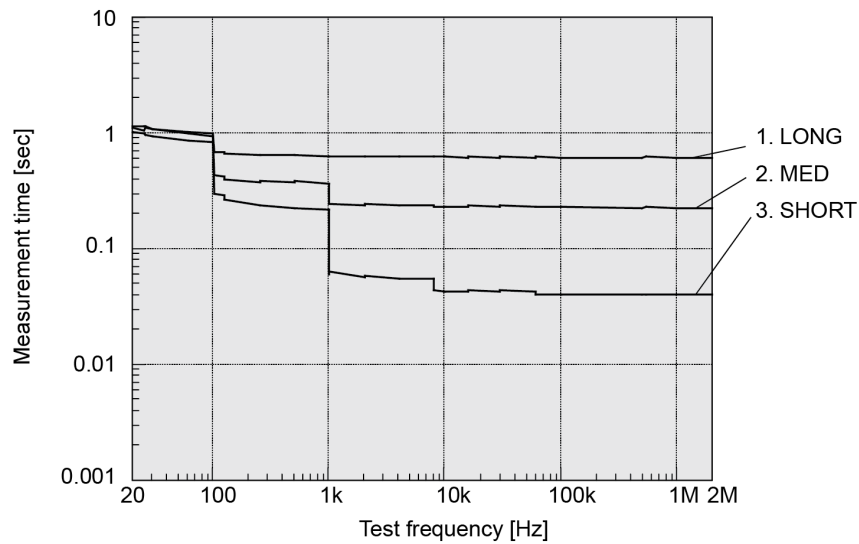

Figure 11. Measurement time (E4980AL)

When DC bias is ON, the following time is added:

Test frequency						
20 Hz	100 Hz	1 kHz	10 kHz	100 kHz	1 MHz	2 MHz
30	30	10	13	2	0.5	0.5

Table 57. Additional time when DC bias is ON [ms]

When the number of averaging increases, the measurement time is given as

Equation 17. $MeasTime + (Ave - 1) \times AveTime$

MeasTime Measurement time calculated based on Table 54, 55 and 56

Ave Number of averaging

AveTime Refer to Table 58

Measurement time mode	Test frequency						
	20 Hz	100 Hz	1 kHz	10 kHz	100 kHz	1 MHz	2 MHz
SHORT	51	11	2.4	2.3	2.3	2.2	2.2
MED	110	81	88	87	85	84	84
LONG	210	210	220	220	220	210	210

Table 58. Additional time per averaging [ms]

Measurement time mode	Test frequency						
	20 Hz	100 Hz	1 kHz	10 kHz	100 kHz	1 MHz	2 MHz
SHORT	210	46	14	14	14	14	14
MED	210	170	170	170	170	170	170
LONG	410	410	410	410	410	410	410

Table 59. Measurement time when Vdc-Idc is selected [ms]

Add the same measurement time per 1 additional average

Additional Measurement time when the Vdc and Idc monitor function is ON. Add SHORT mode of Table 59. When using only Vdc or Idc, add a half of SHORT mode of Table 59.

Measurement time mode	Test frequency						
	20 Hz	100 Hz	1 kHz	10 kHz	100 kHz	1 MHz	2 MHz
SHORT	910	230	43	24	22	22	22
MED	1100	450	300	280	270	270	270
LONG	1400	820	700	670	660	650	650

Table 60. Measurement time when Ls-Rdc or Lp-Rdc is selected [ms]

Add the three times of Table 58 Additional Time per 1 additional average number

Display time

Except for the case of the DISPLAY BLANK page, the time required to update the display on each page (display time) is as follows. When a screen is changed, drawing time and switching time are added. The measurement display is updated about every 100 ms.

Item	When Vdc, Idc monitor is OFF	When Vdc, Idc monitor is ON
MEAS DISPLAY page drawing time	10 ms	13 ms
MEAS DISPLAY page (large) drawing time	10 ms	13 ms
BIN No. DISPLAY page drawing time	10 ms	13 ms
BIN COUNT DISPLAY page drawing time	10 ms	13 ms
LIST SWEEP DISPLAY page drawing time	40 ms	—
Measurement display switching time	35 ms	—

Table 61. Display time

Measurement data transfer time

This table shows the measurement data transfer time under the following conditions. The measurement data transfer time varies depending on measurement conditions and computers.

Host computer:	HP Z420 Workstation, Xeon CPU ES-1620 0 @3.60 GHz
Display:	OFF
Impedance range mode:	AUTO (The overload has not been generated.)
OPEN/SHORT/LOAD compensation:	OFF
Test signal voltage monitor:	OFF

Table 62. Measurement transfer time under the following conditions

Interface	Data transfer format	Using :FETC? command (one point measurement)		Using data buffer memory (list sweep measurement)			
		Comparator ON	Comparator OFF	10 points	51 points	128 points	201 points
GPIB	ASCII	2	2	4	13	28	43
	ASCII Long	2	2	5	15	34	53
	Binary	2	2	4	10	21	36
USB	ASCII	2	2	3	8	16	23
	ASCII Long	2	2	4	9	19	28
	Binary	2	2	3	5	9	13
LAN	ASCII	3	4	5	12	24	36
	ASCII Long	3	3	5	13	29	44
	Binary	3	3	5	9	18	26

Table 63. Measurement data transfer time [ms]

DC bias test signal current (1.5 V/2.0 V): Output current: Max. 20 mA

Option 001 (Power and DC Bias enhance):

DC bias voltage: DC bias voltage applied to DUT is given as:

Equation 18. $V_{dut} = V_b - 100 \times I_b$

V_{dut} [V]	DC bias voltage
V_b [V]	DC bias setting voltage
I_b [A]	DC bias current

DC bias current: DC bias current applied to DUT is given as:

Equation 19. $I_{dut} = V_b / (100 + R_{dc})$

I_{dut} [A] DC bias current
 V_b [V] DC bias setting voltage
 R_{dc} [Ω] DUT's DC resistance

Maximum DC bias current

Impedance range [Ω]	Bias current isolation	OFF	
		Test signal voltage $\leq 2 V_{rms}$	Test signal voltage $> 2 V_{rms}$
0.1	Auto range mode: 100 mA Hold range mode: its values for the range.	20 mA	100 mA
1		20 mA	100 mA
10		20 mA	100 mA
100		20 mA	100 mA
300		2 mA	100 mA
1 k		2 mA	20 mA
3 k		200 μ A	20 mA
10 k		200 μ A	2 mA
30 k		20 μ A	2 mA
100 k		20 μ A	200 μ A

Table 64. Maximum DC bias current when the normal measurement can be performed.

When DC bias is applied to the DUT, add the following value to the absolute accuracy A_b .

SHORT	MED, LONG
$0.05\% \times (100 \text{ mV}/V_s) \times (1 + \sqrt{(100/F_m)})$	$0.01\% \times (100 \text{ mV}/V_s) \times (1 + \sqrt{(100/F_m)})$

Table 65. Only when $F_m < 10 \text{ kHz}$ and $|V_{dc}| > 5 \text{ V}$

F_m [Hz] Test frequency
 V_s [V] Test signal voltage

Relative measurement accuracy with bias current isolation

When DC bias Isolation is set to ON, add the following value to the open offset Y_o .

Equation 20. $Y_o_DCI1 \times (1 + 1/(V_s)) \times (1 + \sqrt{(500/F_m)}) + Y_o_DCI2$

Z_m [Ω] Impedance of DUT
 F_m [Hz] Test frequency
 V_s [V] Test signal voltage
 $Y_o_DCI1,2$ [S] Calculate this by using Table 66 and 67
 I_{dc} [A] DC bias isolation current

DC bias current range	Measurement time mode	
	SHORT	MED, LONG
20 μ A	0 S	0 S
200 μ A	0.25 nS	0.05 nS
2 mA	2.5 nS	0.5 nS
20 mA	25 nS	5 nS
100 mA	250 nS	50 nS

Table 66. Y_o_DCI1 value

DC bias current range	Measurement time mode			
	$\leq 100 \Omega$	300 Ω , 1 k Ω	3 k Ω , 10 k Ω	30 k Ω , 100 k Ω
20 μ A	0 S	0 S	0 S	0 S
200 μ A	0 S	0 S	0 S	0 S
2 mA	0 S	0 S	0 S	3 nS
20 mA	0 S	0 S	30 nS	30 nS
100 mA	0 S	300 nS	300 nS	300 nS

Table 67. Y_o_DCI2 value

DC bias settling time

When DC bias is set to ON, add the following value to the settling time:

	Bias	Settling time
1	Standard	Capacitance of DUT × 100 × loge (2/1.8 m) + 3 m
2	Option 001	Capacitance of DUT × 100 × loge (40/1.8 m) + 3 m

Table 68. DC bias settling time

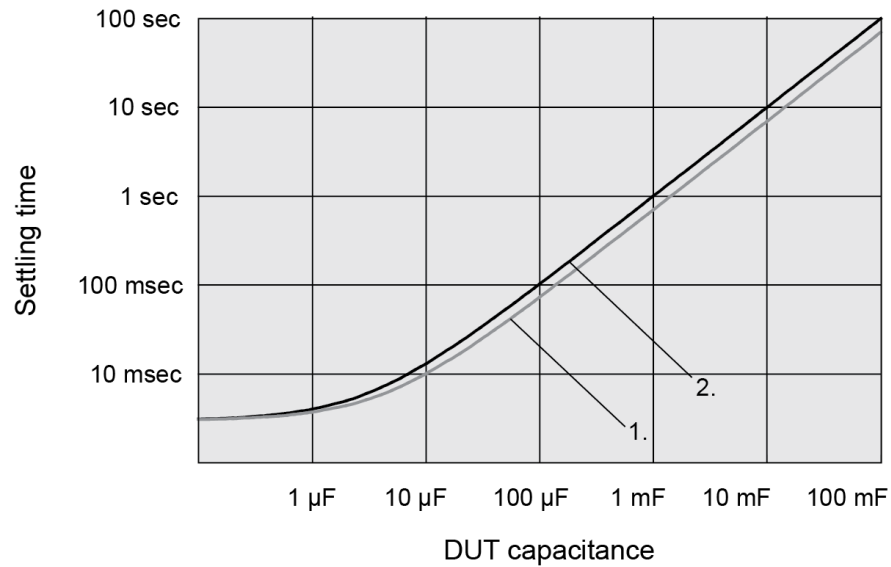

Figure 12. DC bias settling time

Web Resources

Visit our Web sites for additional product information and literature.

E4980A Precision LCR Meter
www.keysight.com/find/e4980a

E4980AL Precision LCR Meter
www.keysight.com/find/e4980al

LCR Meters & Impedance Measurement Products
www.keysight.com/find/impedance

RF & MW test accessories
www.keysight.com/find/mta

Learn more at: www.keysight.com

For more information on Keysight Technologies' products, applications or services, please contact your local Keysight office. The complete list is available at:
www.keysight.com/find/contactus

