

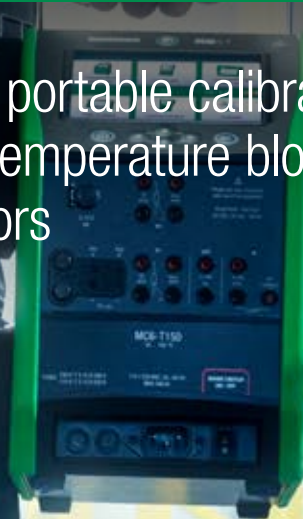

# FIELD EQUIPMENT



The Beamex range of portable calibrators and communicators, temperature blocks and pressure generators



**beamex**  
A BETTER WAY TO CALIBRATE

# Field equipment

Beamex is a technology and service company that develops, manufactures and markets high-quality calibration equipment, software, systems and services for the calibration and maintenance of process instruments. The company is a leading worldwide provider of integrated calibration solutions that meet even the most demanding requirements.

6



## Success stories

10,000 companies worldwide use Beamex calibration solutions. Now you can read some of these success stories.

8



## Solutions

Beamex solutions for paperless calibration, calibration in hazardous areas, plant commissioning as well as configuration and calibration of smart instruments.

19



## MC6



The Beamex MC6 is an advanced, high-accuracy field calibrator and communicator. It offers calibration capabilities for various signals. It also contains a full fieldbus communicator.

39



## MC4



The Beamex MC4 is a compact-sized easy-to-use documenting process calibrator for pressure, electrical and temperature signals.

51



## MC2



The Beamex MC2 is a hand-held documenting calibrator. It has the capability to communicate with Beamex calibration software (CMX and LOGICAL) for fully paperless flow of calibration data.

63



## MC6-Ex



The Beamex MC6-Ex is an ATEX and IECEx certified documenting calibrator designed for use in potentially explosive environments.

79



## MC6-T



The Beamex MC6-T combines a state-of-the-art temperature dry-block with Beamex MC6 multifunction process calibrator technology. It offers versatility, that no other temperature calibrator can match.

99



## MB metrology temperature block

The Beamex MB metrology temperature block is a portable temperature dry block delivering bath-level accuracy for industrial applications.

3

105



## FB field temperature block

The Beamex FB field temperature block is an ideal temperature block for industrial field use. It is lightweight and easy to carry. It is a very fast dry block, yet it provides excellent accuracy.

115



## POC8

The Beamex POC8 is an accurate and user-friendly automatic pressure output controller, providing regulated output from vacuum to 210 bar (3045 psi).

119



## PG pressure generation

The PG series includes five different hand-held calibration pumps for pressure generation: PGM, PGV, PGC, PGHH, PGPH and PGL.

127



## EXT external pressure modules

The Beamex EXT external pressure modules introduce new configuration possibilities and add flexibility, as it is possible to calibrate even more pressure ranges with the same calibrator.

# FIELD EQUIPMENT FEATURE COMPARISON TABLE



FEATURE *	MC6	MC4
Electrical calibrator	●	●
Temperature calibrator	●	●
Temperature generation		
Number of internal pressure modules	3+Barometric	1+Barometric
Compatible with external pressure modules	●	●
ATEX / IECEx certified		
Documenting to PC (CMX software)	●	●
Datalogging	●	
HART communication	●	
FOUNDATION Fieldbus H1 communication	●	
Profibus PA communication	●	
Configuration of HART, Foundation Fieldbus H1 and Profibus PA instruments	●	
Pressure/temperature controller communication	●	
IP65 Water and dust proof	●	
Warranty period (excl. battery)	3 years	2 years

\* Some of the features are optional.

## MB MODEL RANGE

MB140 / MB140R -45 °C ... +140 °C  
 MB155 / MB155R -30 °C ... +155 °C  
 MB425 / MB425R +35 °C ... +425 °C  
 MB700 / MB700R +50 °C ... +700 °C



## FB MODEL RANGE

FB150 / FB150R -25 °C ... +150 °C  
 FB350 / FB350R +33 °C ... +350 °C  
 FB660 / FB660R +50 °C ... +660 °C





MC2

MC6-Ex

MC6-T

•

•

•

•

•

•

•

1+Barometric

2 + Barometric

Barometric

•

•

•

•

•

•

•

•

•

•

•

•

•

•

•

•

•

•

•

2 years

3 years

3 years

**POC8**

- ± 350 mbar / 5 psi
- ± 1 bar / 14.5 psi
- Vacuum to 6 bar / 87 psi
- Vacuum to 20 bar / 290 psi
- Vacuum to 100 bar / 1450 psi
- Vacuum to 210 bar / 3045 psi
- Custom range within -1...210 bar



# SUCCESS STORIES



6

## PHARMACEUTICAL AND HEALTHCARE AstraZeneca, Sweden

AstraZeneca is one of the world's leading biopharmaceutical companies with 30 manufacturing sites in 20 countries. In 2004, Beamex made a corporate agreement with AstraZeneca Sweden Operations. AstraZeneca decided to implement a completely new calibration system including Beamex's CMX calibration management software licenses, training and software support. After implementing the new calibration management process, the entire process takes place digitally, from measurement to signing and archiving. The company performs about 22,000 calibrations annually, which previously engaged 50 employees. Today, the same work can be accomplished with only 15 people.

### **Solution**

- Beamex CMX calibration software
- Beamex MC5 multifunction calibrators

### **Main benefits**

- 1 year pay-off
- Number of databases reduced from 12 to 1
- All paperwork replaced by an electronic calibration process
- Less frequent calibration intervals
- Less labor intense
- Improved overall quality of the calibration process

## SERVICE AND AUTOMATION Endress+Hauser, Germany

Endress+Hauser is the leading international supplier of measuring instruments, services and solutions for process automation. In the past E+H on-site service teams used single signal calibration tools; those tools had long recalibration turn-around-time and caused high internal management effort. Now, however, there is just one multifunction calibration device, one supplier and one certificate replacing 3 to 5 previous devices, certificates and supplier. Since 2006, Endress+Hauser has relied on Beamex process calibrators as well as the services provided by GERMEX GmbH, the exclusive distributor and Premium Partner of Beamex products in Germany. Endress+Hauser has chosen Beamex MC-calibrators as global standard tools to be used for improved efficiency in on-site calibration services and start-up commissioning.

### **Solution**

- Beamex MC6 advanced field calibrator and communicator
- Beamex MC5 multifunction calibrators with Foundation Fieldbus communication
- Beamex MC2 calibrators
- Beamex CMX calibration management software

### **Main benefits**

- Streamlined calibration process
- Short investment payback time
- Decrease in downtime
- Less maintenance costs, due to reduction of calibration tools
- Equipment easy to use
- Reliability, quality and efficiency of services



**FOOD AND BEVERAGE**    **Heineken España, Spain**

The new Heineken España S.A. (JUMBO) brewery in Sevilla is the most modern and productive plant in Europe, allowing the company to remain Spain's market leader in beer. The new plant needed a tool to make calibration work easier, store all calibration results, indicate the calibration history trend and provide quick access to calibration data. These factors led Heineken to choose the Beamex CMX calibration software with the Beamex MC5 multifunction calibrator.

Each instrument that is calibrated regularly has its calibration procedure including the initial calibration date, due date and all calibration related information. Calibration work orders are automatically generated and entered into the SAP PM management system. Once the calibrations are completed, the data is stored in the CMX.

**Solution**

- Beamex CMX calibration software (with Pocket PC option)
- Beamex MC5 multifunction calibrator

**Main benefits**

- Streamlined and automated calibration procedures (e.g. documentation, calibration work procedures)
- Efficient, practical and accurate working methods, minimizing the possibilities for human errors
- Safe calibration system that adheres to regulations (ISO 9001, ISO 14001)
- Improved quality, cost savings and fast ROI for the new calibration system

**WATER AND WASTE WATER SERVICE**    **Miami-Dade WASH, USA**

One of the largest public utilities in the United States, the Miami-Dade Water and Sewer Department (WASH), a department of Miami-Dade county, provides direct service to more than 420,000 customers and employs more than 2,500 workers.

Miami-Dade WASH utilizes the documenting Beamex MC5 multifunction calibrators and Beamex CMX Professional calibration management software, part of the Beamex integrated calibration solution. The MC5 calibrators calibrate the most important plant instruments. CMX is integrated into Miami-Dade WASH's maintenance management software, Infor EAM Enterprise edition, to schedule, perform maintenance and document results.

**Solution**

- Beamex MC5 multifunction calibrators
- Beamex CMX Professional calibration management software

**Main benefits**

- Major improvements in efficiency
- Traceability and accountability
- Safety
- Enhanced quality
- Robust and reliable software
- Integrated system

# SOLUTIONS

## PAPERLESS CALIBRATION

A paperless calibration system comprising documenting calibrators and calibration software improves quality and cuts costs. The business benefits are significant for companies that use software-based calibration systems. The entire calibration process – from initial recording of calibration data to historical trend analysis – will take less time, whilst virtually eliminating mistakes and manual errors.

8



## RELATED PRODUCTS

Beamex MC6 calibrator

Beamex MC6-Ex calibrator

Beamex MC6-T calibrator

Beamex MC4 calibrator

Beamex MC2 calibrator

Beamex CMX Professional calibration software

Beamex CMX Enterprise calibration software

Beamex Business Bridge

Beamex bMobile application





## Traditional paper-based systems

While using a manual, paper-based system requires little or no investment in new technology or IT systems, it is extremely labor-intensive and means that historical trend analysis of calibration results becomes very difficult. In addition, accessing calibration data quickly is not easy. Paper systems are time consuming, they soak up lots of company resources and manual (typing) errors are commonplace. Dual effort and the re-keying of calibration data into multiple databases become significant costs to the business.

## Business benefits of paperless calibration

The business benefits of a paperless calibration system are significant. The entire calibration process – from initial recording of calibration data to historical trend analysis – will take less time, virtually eliminating mistakes and manual errors. In turn, this means that operators, engineers and management will have more confidence in the data, particularly when it comes to plant audits. In addition, this greater confidence in calibration data leads to a better understanding and analysis of business performance and KPIs (particularly if the calibration software is integrated into other business IT systems such as a CMMS) leading to improved processes, increased efficiency and reduced plant downtime.

# STEP-BY-STEP

## BEAMEX INTEGRATED CALIBRATION SOLUTION

### THE CALIBRATION PROCESS

10

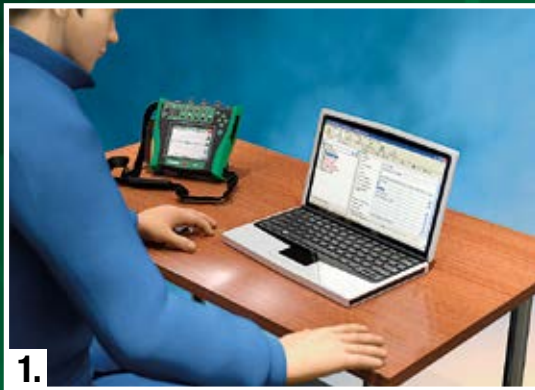

The Beamex CMX alerts what needs to be calibrated and when

- Easy, fast and efficient
- No need to search archived paper files

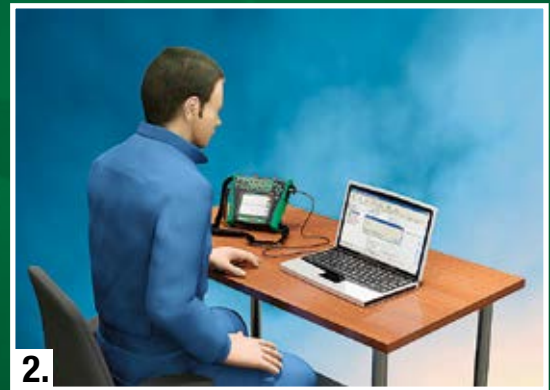

Download calibration procedures and instructions from the software to the MC6

- Fast procedure
- No pen, paper or notepads needed



Create, store and manage calibration information safely and efficiently with the software

- All calibration data is stored and managed in the CMX database
- Calibration certificates, reports and labels in electronic format, on paper or both
- All documentation in the CMX is auditable and traceable (e.g. ISO 17025, cGMP, 21 CFR Part 11)



Integration to a maintenance management system

- Plant hierarchy and work orders are stored in ERP/CMMS (e.g. SAP, Maximo) and from there transferred to the CMX, which stores all calibration procedures, standards and results
- When calibration work has been performed, the CMX sends acknowledgement of the calibration back to ERP/CMMS



3.

**Perform instrument calibration and data collection with the MC6**

- The MC6 replaces many individual measurement devices and calibrators
- Automated calibration is fast



4.

**Upload calibration results to the software**

- Automatically download calibration results back to the software
- Data transfer is fast and efficient, writing mistakes are eliminated



78977348759834759843  
 87984654546546  
 798746546546513213213  
 62587965836458734657  
 665387875684653400

# SOLUTIONS CALIBRATION IN HAZARDOUS AREAS

12

There are industrial environments where calibrations should not only be made accurately and efficiently, but also safely. When safety becomes a top priority in calibration, intrinsically safe calibrators are required. Intrinsic safety (IS) is a protection technique for the safe operation of electronic equipment in explosive environments. The idea behind intrinsic safety is to be assured that the available electrical and thermal energy in the system is always low enough that ignition of the hazardous atmosphere cannot occur.



## RELATED PRODUCTS

Beamex MC6-Ex calibrator





## Intrinsically safe calibrators

An intrinsically safe calibrator is designed to be incapable of causing ignition in the surrounding environment with flammable materials, such as gases, mists, vapors or combustible dust. Intrinsically safe calibrators are also often referred to being “Ex calibrators” or “calibrators for Ex Areas”.

## Where is intrinsically safe calibration required

Many industries require intrinsically safe calibration equipment. Intrinsically safe calibrators are designed for potentially explosive environments, such as oil refineries, rigs and processing plants, gas pipelines and distribution centres, petrochemical and chemical plants, as well as pharmaceutical plants. Basically, any potentially explosive industrial environment can benefit from using intrinsically safe calibrators.

## Benefits of using intrinsically safe calibrators

*Safest possible technique.* Intrinsically safe calibrators are safe for employees, as they can be safely used in environments where the risk of an explosion exists. In addition, intrinsically safe calibrators are the only technique permitted for Zone 0 environments (explosive gas and air mixture is continuously present or present for a long time).

*Performance and functionality.* Multifunctional intrinsically safe calibrators provide the functionality and performance of regular industrial calibration devices, but in a safe way. They can be used for the calibration of pressure, temperature and electrical signals. A documenting intrinsically safe calibrator, such as the Beamex MC6-Ex, provides additional efficiency improvements with its seamless communication with calibration software. This eliminates the need of manual recording of calibration data and improves the quality and productivity of the entire calibration process.

# SOLUTIONS

## CALIBRATION AND CONFIGURATION OF SMART INSTRUMENTS

14

Fieldbus is becoming more and more common in today's instrumentation and fieldbus transmitters must also be calibrated. The fieldbus functionality includes reading the digital output of the fieldbus transmitter, changing the configurations of transmitters and trimming of transmitters.



## RELATED PRODUCTS

Beamex MC6 calibrator

Beamex MC6-Ex calibrator

Beamex MC6-T calibrator





## Fieldbus transmitters must also be calibrated

Are you aware that fieldbus transmitters need to be calibrated just like any other transmitters? The main difference between fieldbus and conventional transmitters is that the output signal is a fully digital fieldbus signal. Although modern fieldbus transmitters have been improved compared to older transmitter models, it does not eliminate the need for calibration. Major time-savings can also be achieved by using the MC6 HART and/or Fieldbus functionality to enter transmitter data into the MC6 memory where the data can then be populated to the CMX calibration software instead of manually entering the data into the calibration database.

There are no such instruments, neither digital nor analog, that would remain stable indefinitely. Therefore, the “digitality” of an instrument does not mean that calibration is unnecessary. There are also many other reasons, such as quality systems and regulations, that make the periodic calibrations compulsory.

## Beamex's fieldbus calibration solution

Beamex offers three products for calibrating fieldbus transmitters: MC6-Ex (intrinsically safe), MC6-T (dry block - temperature calibrator) and MC6.

The MC6 is a one-of-a-kind measurement device being an advanced field calibrator and full multi-bus communicator. The MC6-Ex, MC6-T and MC6 can be used to calibrate HART, FOUNDATION Fieldbus H1 and Profibus PA instruments.



# SOLUTIONS

## COMMISSIONING

Successful commissioning of process instrumentation is an essential requirement for ideal plant performance. A plant, or any defined part of a plant, is ready for commissioning when the plant has achieved mechanical completion. Plant commissioning involves activities such as checking to ensure plant construction is complete and complies with the documented design or approved (authorized and recorded) design changes. In general, commissioning activities are those associated with preparing or operating the plant or any part of the plant prior to the initial start-up and are frequently undertaken by the owner or joint owner/contractor team.

16



## RELATED PRODUCTS

Beamex MC6 calibrator

Beamex MC6-Ex calibrator

Beamex MC6-T calibrator

Beamex MC4 calibrator

Beamex MC2 calibrator

Beamex CMX Professional calibration software

Beamex CMX Enterprise calibration software





## Calibration and commissioning of instrumentation

New process instrumentation is typically configured and calibrated by the manufacturer prior to installation. However, instruments are often recalibrated upon arrival at the site, especially if there has been obvious damage in transit or storage. There are also many other reasons why instruments should be calibrated during the commissioning phase before start-up.

### Assuring transmitter quality

First of all, the fact that an instrument or transmitter is new does not automatically mean that it is within required specifications. Calibrating a new instrument before installing or using it is a quality assurance task. You can check the overall quality of the instrument to see if it is defective and to ensure it has the correct, specified settings.

### Reconfiguring a transmitter

The new uninstalled instrument or transmitter may have the correct, specified settings. However, it is possible that the original planned settings are not valid anymore and they need to be changed. By calibrating an instrument you can check the settings of the instrument. After you have performed this task, it is possible to reconfigure the transmitter, when the initial planned

specifications have been changed. Calibration is therefore a key element in the process of reconfiguring an uninstalled transmitter.

### Monitoring the quality and stability of a transmitter

When calibration procedures are performed for an uninstalled instrument, the calibration serves also future purposes. By calibrating the transmitter before installation and on a regular basis thereafter, it is possible to monitor the stability of the transmitter.

### Entering the necessary transmitter data into a calibration database

By calibrating an instrument before installation it is possible to enter all the necessary instrument data into the calibration database, as well as to monitor the instrument's stability, as was explained in the previous paragraph. The transmitter information is critical in defining the quality of the instrument and for planning the optimal calibration interval of the instrument.



# Beamex MC6

ADVANCED FIELD CALIBRATOR AND COMMUNICATOR



19

The impossible made possible:  
combining advanced functionality with ease-of-use



**beamex**  
A BETTER WAY TO CALIBRATE

78977348759834759833  
87898654546546  
78977348759834759833  
6545678901234567  
855387875684653400



# The impossible made possible: combining advanced functionality with ease-of-use

Beamex MC6 is an advanced, high-accuracy field calibrator and communicator. It offers calibration capabilities for pressure, temperature and various electrical signals. The MC6 also contains a fieldbus communicator for HART, FOUNDATION Fieldbus and Profibus PA instruments.

The usability and ease-of-use are among the main features of the MC6. It has a large 5.7" color touch-screen with a multilingual user interface. The robust IP65-rated dust- and water-proof casing, ergonomic design and light weight make it an ideal measurement device for field use in various industries, such as the pharmaceutical, energy, oil and gas, food and beverage, service as well as the petrochemical and chemical industries.

The MC6 is one device with five different operational modes, which means that it is fast and easy to use, and you can carry less equipment in the field. The operation modes are: meter, calibrator, documenting calibrator, data logger and fieldbus communicator. In addition, the MC6 communicates with Beamex CMX calibration software, enabling fully automated and paperless calibration and documentation.

In conclusion, the MC6 is more than a calibrator.



## MC6 main features

### Accuracy

High-accuracy, advanced field calibrator and communicator.

### Usability

Combines advanced functionality with ease-of-use.

### Versatility

Versatile functionality beyond traditional calibration applications.

### Communicator

Multi-bus communicator for HART, FOUNDATION Fieldbus and Profibus PA instruments.

### Integration

Automates calibration procedures for paperless calibration management.





# High-accuracy, advanced field calibrator and communicator

## Accredited calibration certificate as standard

Each MC6 is delivered with a traceable, accredited calibration certificate as standard. The certificate includes calibration and uncertainty data from the calibration laboratory. The calibration laboratory's Scope of Accreditation can be found on Beamex's website ([www.beamex.com](http://www.beamex.com)).

## Summary of accuracy figures

The MC6 has specifications for short-term accuracy and for 1-year total uncertainty. Brief summary of the accuracy figures:

- Pressure accuracy starting from  $\pm(0.005\% \text{ FS} + 0.0125\% \text{ of reading})$ .
- Temperature – RTD temperature measurement accuracy starting from  $\pm 0.011 \text{ }^\circ\text{C}$ .
- Electric – current measurement accuracy starting from  $\pm(0.75 \text{ } \mu\text{A} + 0.0075\% \text{ of reading})$ .

# Designed for field use

## User-friendly interface

The MC6 has a large 5.7" color touch-screen with high resolution and an effective adjustable backlight. In addition, the MC6 has a membrane keypad. A soft number keypad and alphabetical QWERTY text keypad will appear whenever necessary for easy number/text entries.

## Robust, lightweight and ergonomic design

The MC6 has rechargeable lithium-ion polymer batteries, which are durable and charge up quickly. The user interface keeps you up to date on the remaining operation time in hours and minutes, making it easy to follow how long the battery will last. Once the unit is switched on, it is ready to use in just a few seconds. The case is ergonomic and water-/dust-proof (IP65). There are two types of cases available: a slim case when internal pressure modules are not needed and an extended version, which provides room for the internal pressure modules.



# USER-INTERFACE MODES

## 1. Meter

The meter mode is designed for simple and easy measurement of signals. Oftentimes, you may need to measure something quickly and easily. Often a simple multi-meter is used for this purpose, as it is easy to use. Some multifunctional calibrators may be too slow and difficult to use, so it is easier to just choose the simpler meter. The meter mode in MC6 is optimized for this type of simple and easy metering.



## 2. Calibrator

The calibrator mode is designed for calibrating various process instruments. Oftentimes, you need to check and calibrate a certain process instrument/transmitter. Transmitters typically have an input and an output. So you either need to have two devices, or a device capable of doing two things simultaneously. The calibrator mode in MC6 is optimized for this type of use.



## 3. Data logger

The data logger is designed for logging various measurement results. Often in industry, there is a need to measure signals for shorter or longer periods and to save the results in a memory for later analysis. This may be related to troubleshooting, surveillance or calibration. The data logger mode in MC6 is optimized for this type of use.

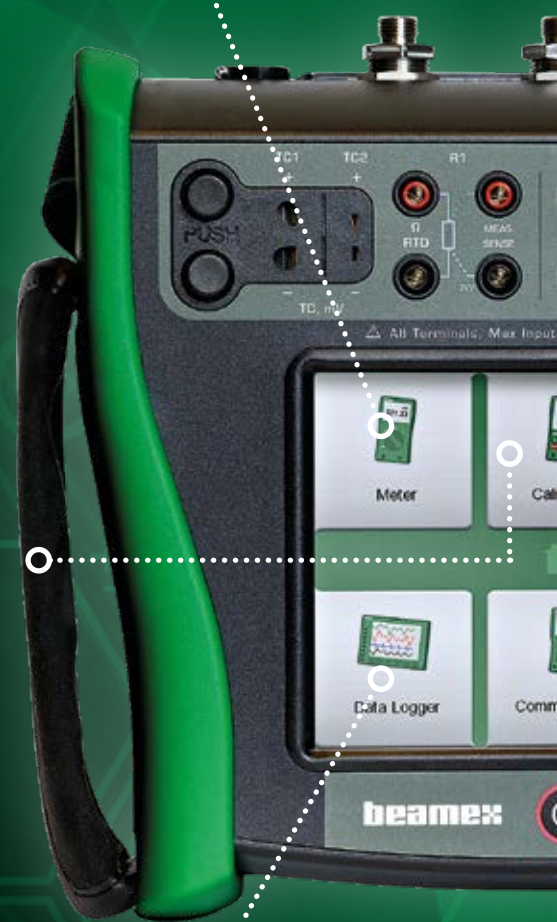
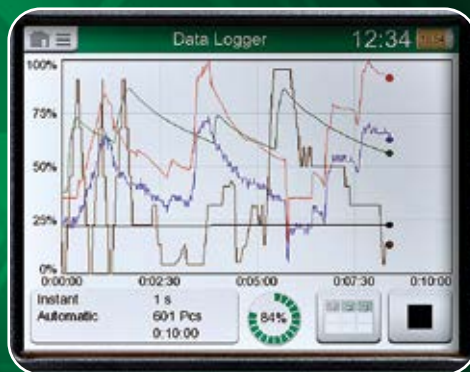





#### 4. Documenting calibrator

The documenting calibrator mode is designed for the process instrument calibration and documenting of the calibration results. In today's process plant, calibrations often have to be documented. Without a documenting calibrator, documentation must be done manually, which takes a lot of precious time and is prone to error. The documenting calibrator mode in MC6 is optimized for use as a documenting process calibrator.



#### 5. Communicator

The communicator mode is designed to communicate with Fieldbus instruments. In today's process plants, smart instrumentation is being used to an increasing degree. Therefore, engineers need to use communicators or configuration software. Most of this instrumentation is HART, FOUNDATION Fieldbus or Profibus PA. The communicator mode in MC6 is optimized for communicator use.



#### 6. Settings

The settings mode allows you to edit the calibrator's various settings.

78977340759834759843  
 87984654546546  
 798746546546513213213  
 62587965836458734657  
 665387875684653400



# Multi-bus field communicator for HART, FOUNDATION Fieldbus and Profibus PA instruments

## Communicator

The communicator mode is a multi-bus communicator for HART, FOUNDATION Fieldbus and Profibus PA instruments. All of the communicator electronics for all protocols are built into the MC6, including internal loop power supply with various required impedances for different buses, which means there is no need to use any external loop supply or resistors.

## Multi-bus communicator

The MC6 communicator can be used with all types of fieldbus instruments, not only pressure and temperature transmitters. All 3 protocols can be simultaneously installed into an MC6, and therefore the very same device can be used as a HART, FOUNDATION Fieldbus and Profibus PA communicator. With the MC6, you can access all parameters in all blocks of a fieldbus instrument. Its memory stores device descriptions for the fieldbus instruments. When new instruments are introduced on the market, new device description files will be made available and can be easily downloaded into the memory.



# Additional features

FEATURE	SPECIFICATION
Scaling	A versatile programmable scaling function allows user to scale any measurement or generation unit into any other unit. Supports also rooting transfer function for flow applications. Also, custom units and custom transfer functions are supported.
Alarm	An alarm that can be programmed with high or low limit, as well as slow rate or fast rate limit.
Leak test	A dedicated function that can be used to analyse a change in any measurement. Can be used for pressure leak testing as well as any stability testing.
Damping	A programmable damping allows user to filter any measurement.
Resolution	Possibility to change the resolution of any measurement by reducing or adding decimals.
Step	A programmable step function for any generation or simulation.
Ramp	A programmable ramp function for any generation or simulation.
Quick access	Possibility to set five (5) quick access buttons in generation to easily generate the programmed values.
Spinner	Possibility to easily step any digit in the generation value up or down.
Additional info	Allow user to see additional information in the screen such as: min, max, rate, average, internal temperature, RTD sensor's resistance, thermocouple's thermovoltage, range min/max, etc.
Function info	Displays more information on the selected function.
Connection diagrams	Displays a picture showing where to connect the test leads with the selected function.
Calibration references	Allows you to document the additional references that were used during the calibration and passes on the information to Beamex CMX calibration software.
Users	Possibility to create a list of persons in the documenting calibrator in order to easily select who did the calibration.
Custom pressure unit	Large number of custom pressure units can be created.
Custom RTD sensor	Unlimited number of custom RTD sensors can be created using the Callendar van Dusen coefficients.
Custom point sets	Unlimited number of custom point sets can be created in calibration of an instrument, or step generation.
Custom transfer function	Unlimited number of custom transfer functions can be created in calibration of an instrument or in scaling function.

Note: All functions are not available in all user interface modes.



# Specifications

## GENERAL SPECIFICATIONS

FEATURE	VALUE
Display	5.7" Diagonal 640 x 480 TFT LCD module
Touch panel	5-wire resistive touch screen
Keyboard	Membrane keyboard
Backlight	LED backlight, adjustable brightness
Weight	Extended case: 1.5...2.0 kg (3.3...4.4 lb) Flat case: 1.5 kg (3.3 lb)
Dimensions	Extended case: 200 mm × 230 mm × 70 mm (D × W × H) (7.87 in × 9.06 in × 2.76 in) Flat case: 200 mm × 230 mm × 57 mm (D × W × H) (7.87 in × 9.06 in × 2.24 in)
Battery type	Rechargeable lithium-ion polymer, 4200 mAh, 11.1V
Charging time	Approximately 4 hours
Charger supply	100...240 VAC, 50–60 Hz
Battery operation	10...16 hours
Operating temperature	–10...45 °C (14...113 °F)
Operating temperature while charging batteries	0...30 °C (32...86 °F)
Storage temperature	–20...60 °C (–4...140 °F)
Specifications valid	–10...45 °C, unless other mentioned
Humidity	0...80% R.H. non condensing
Warmup time	Specifications valid after a 5 minute warmup period.
Max. input voltage	30 V AC, 60 V DC
Display update rate	3 readings/second
Safety	Directive 2014/35/EU, EN 61010-1:2010
EMC	Directive 2014/30/EU, EN 61326-1:2013
Ingress protection	IP65
RoHS compliance	ROHS II Directive 2011/65/EU, EN 50581:2012
Drop	IEC 60068-2-32. 1 meter (3.28 ft)
Vibration	IEC 60068-2-64. Random, 2 g, 5...500 Hz
Max altitude	3,000 m (9,842 ft)
Warranty	Warranty 3 Years. 1 year for battery pack. Warranty extension programs are also available.

## MEASUREMENT, GENERATION AND SIMULATION FUNCTIONS

- Pressure measurement (internal/external pressure modules)
  - Voltage measurement ( $\pm 1$  V and  $-1...60$  VDC)
  - Current measurement ( $\pm 100$  mA) (internal or external supply)
  - Frequency measurement (0...50 kHz)
  - Pulse counting (0...10 Mpulse)
  - Switch state sensing (dry/wet switch)
  - Built-in 24 VDC loop supply (low impedance, HART impedance or FF/PA impedance)
  - Voltage generation ( $\pm 1$  V and  $-3...24$  VDC)
  - Current generation (0...55 mA) (active/passive, i.e. Internal or external supply)
  - Resistance measurement, two simultaneous channels (0...4 k $\Omega$ )
  - Resistance simulation (0...4 k $\Omega$ )
  - RTD measurement, two simultaneous channels
  - RTD simulation
  - TC measurement, two simultaneous channels (universal connector/mini-plug)
  - TC simulation
  - Frequency generation (0...50 kHz)
  - Pulse queue generation (0...10 Mpulse)
  - HART communicator
  - FOUNDATION Fieldbus communicator
  - Profibus PA communicator
- (Some of the above functions are optional)

# PRESSURE MEASUREMENT

INTERNAL MODULES	EXTERNAL MODULES	UNIT	RANGE <sup>(3)</sup>	RESOLUTION	ACCURACY <sup>(1)</sup> (±)	1 YEAR UNCERTAINTY (±) <sup>(2)</sup>
PB	EXT B	kPa a mbar a psi a	70 to 120 700 to 1200 10.15 to 17.4	0.01 0.1 0.001	0.03 kPa 0.3 mbar 0.0044 psi	0.05 kPa 0.5 mbar 0.0073 psi
P10mD	EXT10mD	kPa diff mbar diff iwc diff	±1 ±10 ±4	0.0001 0.001 0.001	0.05% Span	0.05% Span + 0.1% RDG
P100m	EXT100m	kPa mbar iwc	0 to 10 0 to 100 0 to 40	0.0001 0.001 0.001	0.015% FS + 0.0125% RDG	0.025% FS + 0.025% RDG
P400mC	EXT400mC	kPa mbar iwc	±40 ±400 ±160	0.001 0.01 0.001	0.01% FS + 0.0125% RDG	0.02% FS + 0.025% RDG
P1C	EXT1C	kPa bar psi	±100 ±1 -14.5 to 15	0.001 0.00001 0.0001	0.007% FS + 0.0125% RDG	0.015% FS + 0.025% RDG
P2C	EXT2C	kPa bar psi	-100 to 200 -1 to 2 -14.5 to 30	0.001 0.00001 0.0001	0.005% FS + 0.01% RDG	0.01% FS + 0.025% RDG
P6C	EXT6C	kPa bar psi	-100 to 600 -1 to 6 -14.5 to 90	0.01 0.0001 0.001	0.005% FS + 0.01% RDG	0.01% FS + 0.025% RDG
P20C	EXT20C	kPa bar psi	-100 to 2000 -1 to 20 -14.5 to 300	0.01 0.0001 0.001	0.005% FS + 0.01% RDG	0.01% FS + 0.025% RDG
P60	EXT60	kPa bar psi	0 to 6000 0 to 60 0 to 900	0.1 0.001 0.01	0.005% FS + 0.0125% RDG	0.01% FS + 0.025% RDG
P100	EXT100	MPa bar psi	0 to 10 0 to 100 0 to 1500	0.0001 0.001 0.01	0.005% FS + 0.0125% RDG	0.01% FS + 0.025% RDG
P160	EXT160	MPa bar psi	0 to 16 0 to 160 0 to 2400	0.0001 0.001 0.01	0.005% FS + 0.0125% RDG	0.01% FS + 0.025% RDG
-	EXT250	MPa bar psi	0 to 25 0 to 250 0 to 3700	0.001 0.01 0.1	0.007% FS + 0.0125% RDG	0.015% FS + 0.025% RDG
-	EXT600	MPa bar psi	0 to 60 0 to 600 0 to 9000	0.001 0.01 0.1	0.007% FS + 0.01% RDG	0.015% FS + 0.025% RDG
-	EXT1000	MPa bar psi	0 to 100 0 to 1000 0 to 15000	0.001 0.01 0.1	0.007% FS + 0.01% RDG	0.015% FS + 0.025% RDG

<sup>1)</sup> Accuracy includes hysteresis, nonlinearity and repeatability (k=2).

<sup>2)</sup> Uncertainty includes reference standard uncertainty, hysteresis, nonlinearity, repeatability and typical long term stability for mentioned period (k=2).

<sup>3)</sup> Every internal/external gauge pressure module's range may be displayed also in absolute pressure if the barometric module (PB or EXT B) is installed/connected.

Maximum number of internal pressure modules is 3 gauge/differential pressure modules and one barometric (PB) module in the extended case. The flat case has room for internal barometric module only. Both cases have connection for external pressure modules.

External pressure modules are also compatible with Beamex MC2, MC4 and MC5 family calibrators.

## SUPPORTED PRESSURE UNITS

Pa, kPa, hPa, MPa, mbar, bar, gf/cm<sup>2</sup>, kgf/cm<sup>2</sup>, kgf/m<sup>2</sup>, kp/cm<sup>2</sup>, lbf/ft<sup>2</sup>, psi, at, torr, atm, ozf/in<sup>2</sup>, iwc, inH<sub>2</sub>O, ftH<sub>2</sub>O, mmH<sub>2</sub>O, cmH<sub>2</sub>O, mH<sub>2</sub>O, mmHg, cmHg, mHg, inHg, mmHg(0 °C), inHg(0 °C), mmH<sub>2</sub>O(60°F), mmH<sub>2</sub>O(68°F), mmH<sub>2</sub>O(4 °C), cmH<sub>2</sub>O(60°F), cmH<sub>2</sub>O(68°F), cmH<sub>2</sub>O(4 °C), inH<sub>2</sub>O(60°F), inH<sub>2</sub>O(68°F), inH<sub>2</sub>O(4 °C), ftH<sub>2</sub>O(60°F), ftH<sub>2</sub>O(68°F), ftH<sub>2</sub>O(4 °C). Large number of user pressure units can be created.

## TEMPERATURE COEFFICIENT

<±0.001% RDG/ °C outside 15–35 °C (59–95 °F).

P10mD / EXT10mD: < ±0.002% Span/ °C outside 15–35 °C (59–95 °F)

## MAX OVERPRESSURE

2 times the nominal pressure. Except following modules;

PB/EXTB: 1200 mbar abs (35.4 inHg abs). P10mD/EXT10mD: 200 mbar (80 iwc). EXT600: 900 bar (13000 psi). EXT1000: 1000 bar (15000 Psi).

## PRESSURE MEDIA

Modules up to P6C/EXT6C: dry clean air or other clean, inert, non-toxic, non-corrosive gases. Modules P20C/EXT20C and higher: clean, inert, non-toxic, non-corrosive gases or liquids.

## WETTED PARTS

AISI316 stainless steel, Hastelloy, Nitrile rubber

## PRESSURE CONNECTION

PB/EXTB: M5 (10/32") female.

P10mD/EXT10mD: Two M5 (10/32") female threads with hose nipples included.

P100m/EXT100m to P20C/EXT20C: G1/8" (ISO228/1) female. A conical 1/8"

BSP male with 60° internal cone adapter included for Beamex hose set.

P60, P100, P160: G1/8" (ISO228/1) female.

EXT60 to EXT1000: G 1/4" (ISO228/1) male.

# TC MEASUREMENT & SIMULATION

## TC1 measurement & simulation / TC2 measurement

TYPE	RANGE (°C)	RANGE (°C)	ACCURACY <sup>(1)</sup>	1 YEAR UNCERTAINTY (±) <sup>(2)</sup>
B <sup>(3)</sup>	0...1820	0...200	<sup>(8)</sup>	<sup>(4)</sup>
		200...500	1.5 °C	2.0 °C
		500...800	0.6 °C	0.8 °C
		800...1820	0.4 °C	0.5 °C
R <sup>(3)</sup>	-50...1768	-50...0	0.8 °C	1.0 °C
		0...150	0.6 °C	0.7 °C
		150...400	0.35 °C	0.45 °C
		400...1768	0.3 °C	0.4 °C
S <sup>(3)</sup>	-50...1768	-50...0	0.7 °C	0.9 °C
		0...100	0.6 °C	0.7 °C
		100...300	0.4 °C	0.55 °C
		300...1768	0.35 °C	0.45 °C
E <sup>(3)</sup>	-270...1000	-270...-200	<sup>(8)</sup>	<sup>(4)</sup>
		-200...0	0.05 °C + 0.04% RDG	0.07 °C + 0.06% RDG
		0...1000	0.05 °C + 0.003% RDG	0.07 °C + 0.005% RDG
J <sup>(3)</sup>	-210...1200	-210...-200	<sup>(8)</sup>	<sup>(4)</sup>
		-200...0	0.06 °C + 0.05% RDG	0.08 °C + 0.06% RDG
		0...1200	0.06 °C + 0.003% RDG	0.08 °C + 0.006% RDG
K <sup>(3)</sup>	-270...1372	-270...-200	<sup>(8)</sup>	<sup>(4)</sup>
		-200...0	0.08 °C + 0.07% RDG	0.1 °C + 0.1% RDG
		0...1000	0.08 °C + 0.004% RDG	0.1 °C + 0.007% RDG
		1000...1372	0.012% RDG	0.017% RDG
N <sup>(3)</sup>	-270...1300	-270...-200	<sup>(8)</sup>	<sup>(4)</sup>
		-200...-100	0.15% RDG	0.2% RDG
		-100...0	0.11 °C + 0.04% RDG	0.15 °C + 0.05% RDG
		0...800	0.11 °C	0.15 °C
		800...1300	0.06 °C + 0.006% RDG	0.07 °C + 0.01% RDG
T <sup>(3)</sup>	-270...400	-270...-200	<sup>(8)</sup>	<sup>(4)</sup>
		-200...0	0.07 °C + 0.07% RDG	0.1 °C + 0.1% RDG
		0...400	0.07 °C	0.1 °C
U <sup>(5)</sup>	-200...600	-200...0	0.07 °C + 0.05% RDG	0.1 °C + 0.07% RDG
		0...600	0.07 °C	0.1 °C
L <sup>(5)</sup>	-200...900	-200...0	0.06 °C + 0.025% RDG	0.08 °C + 0.04% RDG
		0...900	0.06 °C + 0.002% RDG	0.08 °C + 0.005% RDG
C <sup>(6)</sup>	0...2315	0...1000	0.22 °C	0.3 °C
		1000...2315	0.018% RDG	0.027% RDG
G <sup>(7)</sup>	0...2315	0...60	<sup>(8)</sup>	<sup>(4)</sup>
		60...200	0.9 °C	1.0 °C
		200...400	0.4 °C	0.5 °C
		400...1500	0.2 °C	0.3 °C
		1500...2315	0.014% RDG	0.02% RDG
D <sup>(6)</sup>	0...2315	0...140	0.3 °C	0.4 °C
		140...1200	0.2 °C	0.3 °C
		1200...2100	0.016% RDG	0.024% RDG
		2100...2315	0.45 °C	0.65 °C

Resolution 0.01 °C.

With internal reference junction please see separate specification.

Also other thermocouple types available as option, please contact Beamex.

<sup>1)</sup> Accuracy includes hysteresis, nonlinearity and repeatability (k=2).

<sup>2)</sup> Uncertainty includes reference standard uncertainty, hysteresis, nonlinearity, repeatability and typical long term stability for mentioned period (k=2).

<sup>3)</sup> IEC 584, NIST MN 175, BS 4937, ANSI MC96.1

<sup>4)</sup> ±0.007% of thermovoltage + 4 µV

<sup>5)</sup> DIN 43710

<sup>6)</sup> ASTM E 988 - 96

<sup>7)</sup> ASTM E 1751 - 95e1

<sup>8)</sup> ±0.004% of thermovoltage + 3 µV

<b>Measurement input impedance</b>	> 10 MΩ
<b>Simulation maximum load current</b>	5 mA
<b>Simulation load effect</b>	< 5 µV/mA
<b>Supported units</b>	°C, °F, Kelvin, °Ré, °Ra
<b>Connector</b>	TC1: Universal TC connector , TC2: TC Miniplug

# RTD MEASUREMENT & SIMULATION

## R1 & R2 measurement

SENSOR TYPE	RANGE (°C)	RANGE (°C)	ACCURACY <sup>(1)</sup>	1 YEAR UNCERTAINTY (±) <sup>(2)</sup>
Pt50(385)	-200...850	-200...270 270...850	0.025 °C 0.009% RDG	0.03 °C 0.012% RDG
Pt100(375) Pt100(385) Pt100(389) Pt100(391) Pt100(3926)	-200...850	-200...0 0...850	0.011 °C 0.011 °C + 0.009% RDG	0.015 °C 0.015 °C + 0.012% RDG
Pt100(3923)	-200...600	-200...0 0...600	0.011 °C 0.011 °C + 0.009% RDG	0.015 °C 0.015 °C + 0.012% RDG
Pt200(385)	-200...850	-200...-80 -80...0 0...260 260...850	0.007 °C 0.016 °C 0.016 °C + 0.009% RDG 0.03 °C + 0.011% RDG	0.01 °C 0.02 °C 0.02 °C + 0.012% RDG 0.045 °C + 0.02% RDG
Pt400(385)	-200...850	-200...-100 -100...0 0...850	0.007 °C 0.015 °C 0.026 °C + 0.01% RDG	0.01 °C 0.02 °C 0.045 °C + 0.019% RDG
Pt500(385)	-200...850	-200...-120 -120...-50 -50...0 0...850	0.008 °C 0.013 °C 0.025 °C 0.025 °C + 0.01% RDG	0.01 °C 0.02 °C 0.045 °C 0.045 °C + 0.019% RDG
Pt1000(385)	-200...850	-200...-150 -150...-50 -50...0 0...850	0.007 °C 0.018 °C 0.022 °C 0.022 °C + 0.01% RDG	0.008 °C 0.03 °C 0.04 °C 0.04 °C + 0.019% RDG
Ni100(618)	-60...180	-60...0 0...180	0.009 °C 0.009 °C + 0.005% RDG	0.012 °C 0.012 °C + 0.006% RDG
Ni120(672)	-80...260	-80...0 0...260	0.009 °C 0.009 °C + 0.005% RDG	0.012 °C 0.012 °C + 0.006% RDG
Cu10(427)	-200...260	-200...260	0.012 °C	0.16 °C

32

## R1 Simulation

SENSOR TYPE	RANGE (°C)	RANGE (°C)	ACCURACY <sup>(1)</sup>	1 YEAR UNCERTAINTY (±) <sup>(2)</sup>
Pt50(385)	-200...850	-200...270 270...850	0.055 °C 0.035 °C + 0.008% RDG	0.11 °C 0.11 °C + 0.015% RDG
Pt100(375) Pt100(385) Pt100(389) Pt100(391) Pt100(3926)	-200...850	-200...0 0...850	0.025 °C 0.025 °C + 0.007% RDG	0.05 °C 0.05 °C + 0.014% RDG
Pt100(3923)	-200...600	-200...0 0...600	0.025 °C 0.025 °C + 0.007% RDG	0.05 °C 0.05 °C + 0.014% RDG
Pt200(385)	-200...850	-200...-80 -80...0 0...260 260...850	0.012 °C 0.02 °C 0.02 °C + 0.006% RDG 0.03 °C + 0.011% RDG	0.025 °C 0.035 °C 0.04 °C + 0.011% RDG 0.06 °C + 0.02% RDG
Pt400(385)	-200...850	-200...-100 -100...0 0...850	0.01 °C 0.015 °C 0.027 °C + 0.01% RDG	0.015 °C 0.03 °C 0.05 °C + 0.019% RDG
Pt500(385)	-200...850	-200...-120 -120...-50 -50...0 0...850	0.008 °C 0.012 °C 0.026 °C 0.026 °C + 0.01% RDG	0.015 °C 0.025 °C 0.05 °C 0.05 °C + 0.019% RDG
Pt1000(385)	-200...850	-200...-150 -150...-50 -50...0 0...850	0.006 °C 0.017 °C 0.023 °C 0.023 °C + 0.01% RDG	0.011 °C 0.03 °C 0.043 °C 0.043 °C + 0.019% RDG
Ni100(618)	-60...180	-60...0 0...180	0.021 °C 0.019 °C	0.042 °C 0.037 °C + 0.001% RDG
Ni120(672)	-80...260	-80...0 0...260	0.021 °C 0.019 °C	0.042 °C 0.037 °C + 0.001% RDG
Cu10(427)	-200...260	-200...260	0.26 °C	0.52 °C

For platinum sensors ITS-90 and Callendar van Dusen coefficients can be programmed. Also other RTD types available as option, please contact Beamex.



FEATURE	SPECIFICATION
RTD Measurement current	Pulsed, bi-directional 1 mA (0..500 Ω), 0.2 mA (> 500 Ω)
4-wire connection	Measurement specifications valid
3-wire measurement	Add 10 mΩ
Max resistance excitation current	5 mA (0...650 Ω). $I_{exc} \times R_{sim} < 3.25 \text{ V}$ (650...4000 Ω)
Min resistance excitation current	> 0.2 mA (0...400 Ω). > 0.1 mA (400...4000 Ω)
Simulation settling time with pulsed excitation current	< 1 ms
Supported units	°C, °F, Kelvin, °Ré, °Ra

## Internal reference junction TC1 & TC2

RANGE (°C)	ACCURACY <sup>1</sup>	1 YEAR UNCERTAINTY <sup>2</sup>
-10...45 °C	±0.10 °C	±0.15 °C

Specifications valid in temperature range: 15...35 °C.

Temperature coefficient outside of 15...35 °C: ±0.005 °C/ °C.

Specifications assumes that calibrator has stabilized in environmental condition, being switched on, for minimum of 90 minutes. For a measurement or simulation done sooner than that, please add uncertainty of 0.15 °C.

In order to calculate the total uncertainty of thermocouple measurement or simulation with internal reference junction used, please add the relevant thermocouple uncertainty and the reference junction uncertainty together as a root sum of the squares.

## VOLTAGE MEASUREMENT

### IN (-1...60 V)

RANGE	RESOLUTION	ACCURACY <sup>1</sup>	1 YEAR UNCERTAINTY <sup>2</sup>
-1.01...1 V	0.001 mV	3 μV + 0.003% RDG	5 μV + 0.006% RDG
1...60.6 V	0.01 mV	0.125 mV + 0.003% RDG	0.25 mV + 0.006% RDG
<b>Input impedance</b>		> 2 MΩ	
<b>Supported units</b>		V, mV, μV	

### TC1 & TC2 (-1...1 V)

RANGE	RESOLUTION	ACCURACY <sup>1</sup>	1 YEAR UNCERTAINTY <sup>2</sup>
-1.01...1.01 V	0.001 mV	3 μV + 0.004% RDG	4 μV + 0.007% RDG
<b>Input impedance</b>		> 10 MΩ	
<b>Supported units</b>		V, mV, μV	
<b>Connector</b>		TC1: Universal TC connector , TC2: TC Miniplug	

<sup>1</sup> Accuracy includes hysteresis, nonlinearity and repeatability (k=2).

<sup>2</sup> Uncertainty includes reference standard uncertainty, hysteresis, nonlinearity, repeatability and typical long term stability for mentioned period (k=2).

## VOLTAGE GENERATION

### OUT (-3...24 V)

RANGE	RESOLUTION	ACCURACY <sup>(1)</sup>	1 YEAR UNCERTAINTY <sup>(2)</sup>
-3...10 V	0.00001 V	0.05 mV + 0.004% RDG	0.1 mV + 0.007% RDG
10...24 V	0.0001 V	0.05 mV + 0.004% RDG	0.1 mV + 0.007% RDG
<b>Maximum load current</b>		10 mA	
<b>Short circuit current</b>		>100 mA	
<b>Load effect</b>		< 50 $\mu$ V/mA	
<b>Supported units</b>		V, mV, $\mu$ V	

### TC1 (-1...1 V)

RANGE	RESOLUTION	ACCURACY <sup>(1)</sup>	1 YEAR UNCERTAINTY <sup>(2)</sup>
-1...1 V	0.001 mV	3 $\mu$ V + 0.004% RDG	4 $\mu$ V + 0.007% RDG
<b>Maximum load current</b>		5 mA	
<b>Load effect</b>		< 5 $\mu$ V/mA	
<b>Supported units</b>		V, mV, $\mu$ V	

34

## CURRENT MEASUREMENT

### IN (-100...100 mA)

RANGE	RESOLUTION	ACCURACY <sup>(1)</sup>	1 YEAR UNCERTAINTY <sup>(2)</sup>
-25...25 mA	0.0001 mA	0.75 $\mu$ A + 0.0075% RDG	1 $\mu$ A + 0.01% RDG
$\pm$ (25...101 mA)	0.001 mA	0.75 $\mu$ A + 0.0075% RDG	1 $\mu$ A + 0.01% RDG
<b>Input impedance</b>		< 10 $\Omega$	
<b>Supported units</b>		mA, $\mu$ A	
<b>Loop supply</b>		Internal 24 V $\pm$ 10% (max 55 mA), or external max 60 VDC	

## CURRENT GENERATION

### OUT (0...55 mA)

RANGE	RESOLUTION	ACCURACY <sup>(1)</sup>	1 YEAR UNCERTAINTY <sup>(2)</sup>
0...25 mA	0.0001 mA	0.75 $\mu$ A + 0.0075% RDG	1 $\mu$ A + 0.01% RDG
25...55 mA	0.001 mA	1.5 $\mu$ A + 0.0075% RDG	2 $\mu$ A + 0.01% RDG
<b>Internal loop supply</b>		24 V $\pm$ 5%. Max 55 mA.	
<b>Max load impedance w. internal supply</b>		24 V / (generated current). 1140 $\Omega$ @ 20 mA, 450 $\Omega$ @ 50 mA	
<b>Max external loop supply</b>		60 VDC	
<b>Supported units</b>		mA, $\mu$ A	

<sup>1)</sup> Accuracy includes hysteresis, nonlinearity and repeatability (k=2).

<sup>2)</sup> Uncertainty includes reference standard uncertainty, hysteresis, nonlinearity, repeatability and typical long term stability for mentioned period (k=2).

## FREQUENCY MEASUREMENT

### IN (0.0027...51000 Hz)

RANGE	RESOLUTION	ACCURACY <sup>(1)</sup>	1 YEAR UNCERTAINTY <sup>(2)</sup>
0.0027...0.5 Hz	0.000001 Hz	0.000002 Hz + 0.001% RDG	0.000002 Hz + 0.002% RDG
0.5...5 Hz	0.00001 Hz	0.00002 Hz + 0.001% RDG	0.00002 Hz + 0.002% RDG
5...50 Hz	0.0001 Hz	0.0002 Hz + 0.001% RDG	0.0002 Hz + 0.002% RDG
50...500 Hz	0.001 Hz	0.002 Hz + 0.001% RDG	0.002 Hz + 0.002% RDG
500...5000 Hz	0.01 Hz	0.02 Hz + 0.001% RDG	0.02 Hz + 0.002% RDG
5000...51000 Hz	0.1 Hz	0.2 Hz + 0.001% RDG	0.2 Hz + 0.002% RDG

<b>Input impedance</b>	>1 MΩ
<b>Supported units</b>	Hz, kHz, cph, cpm, 1/Hz(s), 1/kHz(ms), 1/MHz(μs)
<b>Trigger level</b>	Dry contact, wet contact -1...14 V
<b>Minimum signal amplitude</b>	1.0 Vpp (<10kHz), 1.2 Vpp (10...50 kHz)

## FREQUENCY GENERATION

### OUT (0.0005...50000 Hz)

RANGE	RESOLUTION	ACCURACY <sup>(1)</sup>	1 YEAR UNCERTAINTY <sup>(2)</sup>
0.0005...0.5 Hz	0.000001 Hz	0.000002 Hz + 0.001% RDG	0.000002 Hz + 0.002% RDG
0.5...5 Hz	0.00001 Hz	0.00002 Hz + 0.001% RDG	0.00002 Hz + 0.002% RDG
5...50 Hz	0.0001 Hz	0.0002 Hz + 0.001% RDG	0.0002 Hz + 0.002% RDG
50...500 Hz	0.001 Hz	0.002 Hz + 0.001% RDG	0.002 Hz + 0.002% RDG
500...5000 Hz	0.01 Hz	0.02 Hz + 0.001% RDG	0.02 Hz + 0.002% RDG
5000...50000 Hz	0.1 Hz	0.2 Hz + 0.001% RDG	0.2 Hz + 0.002% RDG

<b>Maximum load current</b>	10 mA
<b>Wave forms</b>	Positive square, symmetric square
<b>Output amplitude positive square wave</b>	0...24 Vpp
<b>Output amplitude symmetric square wave</b>	0...6 Vpp
<b>Duty Cycle</b>	1...99%
<b>Amplitude accuracy</b>	< 5% of amplitude
<b>Supported units</b>	Hz, kHz, cph, cpm, 1/Hz(s), 1/kHz(ms), 1/MHz(μs)

35

## PULSE COUNTING

### IN (0...9 999 999 pulses)

FEATURE	SPECIFICATION
Input impedance	>1 MΩ
Trigger level	Dry contact, wet contact -1...14 V
Minimum signal amplitude	1 Vpp (< 10 kHz), 1.2 Vpp (10...50 kHz)
Max frequency	50 kHz
Trigger edge	Rising, falling

<sup>1)</sup> Accuracy includes hysteresis, nonlinearity and repeatability (k=2).

<sup>2)</sup> Uncertainty includes reference standard uncertainty, hysteresis, nonlinearity, repeatability and typical long term stability for mentioned period (k=2).

# PULSE GENERATION

## OUT (0...9 999 999 pulses)

FEATURE	SPECIFICATION
Resolution	1 pulse
Maximum load current	10 mA
Output amplitude positive pulse	0...24 Vpp
Output amplitude symmetric pulse	0...6 Vpp
Pulse frequency range	0.0005...10000 Hz
Duty cycle	1...99%

# RESISTANCE MEASUREMENT

## R1 & R2 (0...4000 Ω)

RANGE	RESOLUTION	ACCURACY <sup>(1)</sup>	1 YEAR UNCERTAINTY <sup>(2)</sup>
-1...100 Ω	0.001 Ω	4.5 mΩ	6 mΩ
100...110 Ω	0.001 Ω	0.0045% RDG	0.006% RDG
110...150 Ω	0.001 Ω	0.005% RDG	0.007% RDG
150...300 Ω	0.001 Ω	0.006% RDG	0.008% RDG
300...400 Ω	0.001 Ω	0.007% RDG	0.009% RDG
400...4040 Ω	0.01 Ω	9 mΩ + 0.008% RDG	12 mΩ + 0.015% RDG

<b>Measurement current</b>	Pulsed, bi-directional 1 mA (0..500 Ω), 0.2 mA (>500 Ω)
<b>Supported units</b>	Ω, kΩ
<b>4-wire connection</b>	Measurement specifications valid
<b>3-wire measurement</b>	Add 10 mΩ

# RESISTANCE SIMULATION

## R1 (0...4000 Ω)

RANGE	RESOLUTION	ACCURACY <sup>(1)</sup>	1 YEAR UNCERTAINTY <sup>(2)</sup>
0...100 Ω	0.001 Ω	10 mΩ	20 mΩ
100...400 Ω	0.001 Ω	5 mΩ + 0.005% RDG	10 mΩ + 0.01% RDG
400...4000 Ω	0.01 Ω	10 mΩ + 0.008% RDG	20 mΩ + 0.015% RDG

<b>Max resistance excitation current</b>	5 mA (0...650 Ω). $I_{exc} \times R_{sim} < 3.25 \text{ V}$ (650...4000 Ω)
<b>Min resistance excitation current</b>	> 0.2 mA (0...400 Ω). >0.1 mA (400...4000 Ω)
<b>Settling time with pulsed excitation current</b>	< 1ms
<b>Supported units</b>	Ω, kΩ

<sup>1)</sup> Accuracy includes hysteresis, nonlinearity and repeatability (k=2).

<sup>2)</sup> Uncertainty includes reference standard uncertainty, hysteresis, nonlinearity, repeatability and typical long term stability for mentioned period (k=2).

# Modularity, options and accessories

## MODULARITY AND OPTIONS

- All electrical / temperature functions are included as standard
- Two case bottom choices:
  - flat (no room for internal pressure modules, only barometer)
  - extended (room for internal pressure modules)
- Optional internal pressure modules (up to four internal pressure modules; three standard and one barometric)
- Optional user-interface modes:
  - Documenting calibrator
  - Data logger
  - HART communicator
  - FOUNDATION Fieldbus communicator
  - Profibus PA communicator
- Pressure / temperature controller communications



37

## STANDARD ACCESSORIES

- Accredited calibration certificate
- User guide
- Computer cable (USB)
- Battery charger / eliminator
- Internal LiPO battery pack
- Test leads and clips



## OPTIONAL ACCESSORIES

- Soft carrying case
- Soft accessory case
- Hard carrying case
- Spare battery pack
- Adapter cables for the second RTD channel
- Cable for pressure and temperature controllers
- Appropriate pressure T-hose with internal low pressure modules



# Beamex MC6

## ADVANCED FIELD CALIBRATOR AND COMMUNICATOR

38

Beamex MC6 is an advanced, high-accuracy field calibrator and communicator. It offers calibration capabilities for pressure, temperature and various electrical signals. The MC6 also contains a full fieldbus communicator for HART, FOUNDATION Fieldbus and Profibus PA instruments. The MC6 is one device with five different operational modes, which means that it is fast and easy to use, and you can carry less equipment in the field. The operation modes are: meter, calibrator, documenting calibrator, data logger and fieldbus communicator. In addition, the MC6 communicates with Beamex CMX calibration software, enabling fully automated and paperless calibration and documentation.

### Guided procedures

The MC6 provides automated, guided procedures. For instance, whenever a certain measurement or generation is selected, the user interface shows where to make the connections.

### Paperless calibration

The MC6 communicates with calibration software enabling fully automated and paperless calibration and documentation.

### One device, five operational modes

How is it possible to combine advanced functionality with ease-of-use? In the MC6 this has been achieved through integrating various operational modes into one device. This means that you only need to learn how to use one device.

### Communicator

Smart instrumentation is becoming more and more common in today's process plants. The most widely used smart instrument protocols are HART, FOUNDATION Fieldbus and Profibus PA. Therefore, in addition to a calibrator, an engineer often needs to use a field communicator. The MC6 combines these two; it's a calibrator and a communicator.



### Main features

- ▶ High-accuracy calibrator for pressure, temperature and electrical signals
- ▶ Full multi-bus communicator for HART, FOUNDATION Fieldbus and Profibus PA instruments
- ▶ Five operational modes: meter, calibrator, documenting calibrator, data logger and communicator
- ▶ Combines advanced functionality with ease-of-use
- ▶ Automates calibration procedures for paperless calibration management



# Beamex MC4

DOCUMENTING PROCESS CALIBRATOR



Document as you go



**beamex**  
A BETTER WAY TO CALIBRATE

79977348759834759833  
87984654546546  
79977348759834759833  
655387875684653403





# MC4: a compact, easy-to-use documenting process calibrator

The Beamex MC4 is a documenting process calibrator. Instrument data can be sent from a computer to the MC4 and calibration results can be uploaded from the MC4 to a computer containing the Beamex CMX calibration software. Being a multifunctional calibrator, the MC4 is suitable for calibrating various process parameters, such as pressure, temperature and electrical signals.

High accuracy is one of the important features of the MC4. A standard feature of the MC4 includes an accredited calibration certificate as proof of its accuracy. The correction coefficients of a PRT probe can be programmed into the MC4 to further improve temperature accuracy. The large graphical display, menu-based multilingual user interface and full numerical keyboard make it easy to use.



## Main features of MC4

### Communication with calibration software

Using the MC4 together with a calibration software provides you with a complete documenting calibration system that produces calibration certificates automatically.

### All-in-one functionality

The MC4 is a versatile calibrator with many different functions. There's no need to take several different measurement devices to the field – the MC4 does the job.

### Accuracy guaranteed

The MC4 is a highly accurate process calibrator. As a proof of this, each calibrator is delivered with a traceable, accredited calibration certificate.

### Calibration is quick and easy

The large graphical display, menu-based multilingual user interface and full numerical keyboard make the MC4 quick and easy to use.



# Advanced features of MC4

FEATURE	SPECIFICATION
Calibration mode	The MC4 includes a versatile calibration mode making it easy and effective to create and calibrate process instruments.
PRT sensor coefficients	The MC4 compensates sensor errors because it includes the possibility to record PRT sensor correction coefficients.
Error% display	When calibrating a transmitter, its output may be displayed in an error% unit rather than in an engineering unit.
Error display in input or output units	When calibrating a transmitter, the transmitter's output may be displayed as an error in input or output engineering units.
% display	Any measurement or generation may be presented in percentages within the user-programmable range.
Scaling	A versatile, programmable scaling function allows the user to scale any measured or generated unit into any custom unit. Scaling also includes a rooting transfer function for flow applications as well as custom transfer functions.
User setups	The unit has a large number of user-configurable setups that make it easy to save and quickly recall a desired configuration.
Leak testing	The leak test function indicates pressure drops and leak rates during the user-programmable period.
Step and ramp	The unit includes a versatile and programmable automatic step and ramp function as well as a manual step function.
Programmable alarms	An alarm based on a measurement value or rate of change can be programmed into the device.
Damping	Programmable damping allows the user to select different filters for measurements.
Bar graph	The bar graph allows the user to display a measurement or generation as an analogue bar, including programmable starting and ending points.
Difference	Difference measurement allows the user to measure the difference between two pressure modules.
Deviation	The deviation function allows the user to display a deviation between a given reference value and the actual measurement.
Redundancy	Redundancy measurement allows the user to measure the same pressure using two pressure modules (internal and external) simultaneously. The unit's alarm sounds if the readings excessively differ from each other.
Additional information	The unit also allows the user to view additional information such as min, max, rate, internal temperature, thermocouple's thermovoltage, RTD sensor's resistance etc.



# General specifications

FEATURE	SPECIFICATION
Display	60 mm x 60 mm (2.36" x 2.36"), 160 x 160 pixels, back lit LCD
Weight	720...830 g (1.59...1.83 lbs)
Dimensions	215 mm (8.5") x 102 mm (4") x 49 mm (1.9") (d/w/h)
Keyboard	Membrane keyboard
Battery type	Rechargeable NiMH pack, 4000 mAh, 3.6V DC
Charging time	5 hours
Charger supply	100...240 VAC, 50–60 Hz
Battery operation	13...24 hours in measurement mode, back light off. 8...12 hours when sourcing an average of 12 mA to loop, with back light on.
Battery operation with optional dry battery cartridge and 4 alkaline AA cells	4...8 hours in measurement mode, back light off. 3...4 hours when sourcing an average of 12 mA to loop, with back light on.
Operating temperature	–10...50 °C (14...122°F)
Operating temp. while charging batteries	0...35 °C (32...95°F)
Storage temperature	–20...60 °C (–4...140°F)
Humidity	0 to 80% R.H. non-condensing
Warm-up time	Specifications valid after a 5-minute warm-up period.
Max. input voltage	30 V AC, 60 V DC
Safety	Directive 2014/35/EU, EN 61010-1:2010
EMC	Directive 2014/30/EU, EN 61326-1:2013
RoHS compliance	RoHS II Directive 2011/65/EU
Warranty	Warranty 2 Years. 1 year for battery pack. Additional warranty extension programs available.

## VOLTAGE MEASUREMENT –1...60 V DC

RANGE	RESOLUTION	1 YEAR UNCERTAINTY (±) <sup>(1)</sup>
±0.25 V	0.001mV	0.02% RDG + 5 µV
±(0.25...1 V)	0.01 mV	0.02% RDG + 5 µV
1...25 V	0.1 mV	0.02% RDG + 0.25 mV
25...60 V	1 mV	0.02% RDG + 0.25 mV

FEATURE	SPECIFICATION
Temperature coefficient	< ±0.0015% RDG / °C outside of 18...28 °C < ±0.0008% RDG / °F outside of 64.4...82.4°F
Input impedance	>1 MΩ
Supported units	V, mV, µV
Display update rate	3 / second

## mA MEASUREMENT ±100 mA

RANGE	RESOLUTION	1 YEAR UNCERTAINTY (±) <sup>(1)</sup>
±25mA	0.0001 mA	0.02% RDG + 1.5 µA
±(25...100 mA)	0.001 mA	0.02% RDG + 1.5 µA

FEATURE	SPECIFICATION
Temperature coefficient	< ±0.0015% RDG / °C outside of 18...28 °C < ±0.0008% RDG / °F outside of 64.4...82.4°F
Input impedance	< 7.5 Ω
Supported units	mA, µA
Display update rate	3 / second

## LOOP SUPPLY

FEATURE	SPECIFICATION
Maximum output current	> 25 mA, short circuit protected
Output voltage	24 V ±10%
Output impedance in HART compatible mode	300 Ω ±20%

<sup>(1)</sup> Uncertainty includes reference standard uncertainty, hysteresis, non-linearity, repeatability and typical long-term stability for the mentioned period (k=2).

# Electrical measurements

## FREQUENCY MEASUREMENT 0.0027...50 000 Hz

RANGE	RESOLUTION	1 YEAR UNCERTAINTY ( $\pm$ ) <sup>1)</sup>
0.0027...0.5 Hz	0.000001 Hz	0.01% RDG
0.5...5 Hz	0.00001 Hz	0.01% RDG
5...50 Hz	0.0001 Hz	0.01% RDG
50...500 Hz	0.001 Hz	0.01% RDG
500...5000 Hz	0.01 Hz	0.01% RDG
5000...50000 Hz	0.1 Hz	0.01% RDG

FEATURE	SPECIFICATION
Temperature coefficient	Specification valid from -10 to 50 °C (14...122°F)
Input impedance	> 1 M $\Omega$
Trigger level	-1...14 V in 1 V steps and open collector inputs
Minimum signal amplitude	2 Vpp (< 10 kHz), 3 Vpp (10...50 kHz)
Supported units	Hz, kHz, cph, cpm, 1/Hz (s), 1/kHz (ms), 1/MHz ( $\mu$ s)
Gate period	267 ms + 1 signal period

1) Uncertainty includes reference standard uncertainty, hysteresis, non-linearity, repeatability and typical long-term stability for the mentioned period (k=2).

44

## PULSE COUNTING 0...9 999 999 PULSES

FEATURE	SPECIFICATION
Range	0 to 9 999 999 pulses
Input impedance	> 1 M $\Omega$
Trigger level	-1...14 V in 1 V steps and open collector inputs
Minimum signal amplitude	2 Vpp (pulse length > 50 $\mu$ s), 3 Vpp (pulse length 10...50 $\mu$ s)

## SWITCH TEST

FEATURE	SPECIFICATION	
Potential free contacts	Test voltage (trigger level)	3 V, 0.13 mA (1 V) or 24 V, 35 mA (2 V)
Voltage level detection	Trigger level Input impedance	-1...14 V in 1 V steps > 1 M $\Omega$

# Pressure measurements

## INTERNAL PRESSURE MODULES (NPM)

INTERNAL MODULE <sup>3)</sup>	UNIT	RANGE <sup>2)</sup>	RESOLUTION	1 YEAR UNCERTAINTY ( $\pm$ ) <sup>1)</sup>
NPM200mC	kPa	$\pm 20$	0.001	0.035% FS + 0.05% RDG
	mbar	$\pm 200$	0.01	
	iwc	$\pm 80$	0.001	
NPM2C	kPa	-100 to 200	0.001	0.015% FS + 0.035% RDG
	bar	-1 to 2	0.00001	
	psi	-14.5 to 30	0.001	
NPM20C	kPa	-100 to 2000	0.01	0.015% FS + 0.035% RDG
	bar	-1 to 20	0.0001	
	psi	-14.5 to 300	0.01	
NPM160	MPa	0...16	0.0001	0.015% FS + 0.035% RDG
	bar	0...160	0.001	
	psi	0...2400	0.01	
Barometric option	Also enables absolute pressure measurement for the above pressure inputs. When using the barometric option, add 0.1 kPa (0.0146 psi) uncertainty for absolute pressure measurement.			

FEATURE	SPECIFICATION
Temperature coefficient	< $\pm 0.001\%$ RDG / °C outside 15...35 °C < $\pm 0.0006\%$ RDG / °F outside 59...95 °F
Maximum overpressure	2 x Range
Pressure port	G 1/8" female with G 1/8" male (ISO 228/1) 60° internal cone adapter NPM160: G 1/8" female
Media compatibility	Wetted parts: AISI316 stainless steel, Nitrile rubber.
Supported pressure units	Pa, hPa, kPa, MPa, mbar, bar, lbf/ft <sup>2</sup> , psi, ozf/in <sup>2</sup> , gf/cm <sup>2</sup> , kgf/cm <sup>2</sup> , kgf/m <sup>2</sup> , kp/cm <sup>2</sup> , at, mmH <sub>2</sub> O, cmH <sub>2</sub> O, mH <sub>2</sub> O, iwc, ftH <sub>2</sub> O, mmHg, cmHg, mHg, inHg, mmHg(0 °C), inHg(0 °C), mmH <sub>2</sub> O(4 °C; 60°F; 68°F/20 °C), cmH <sub>2</sub> O(4 °C; 60°F; 68°F/20 °C), inH <sub>2</sub> O(4 °C; 60°F; 68°F/20 °C), ftH <sub>2</sub> O(4 °C; 60°F; 68°F/20 °C), torr, atm, + four (4) user-configurable units
Display update rate	2.5 / second

45

## EXTERNAL PRESSURE MODULES (EXT) STANDARD ACCURACY

EXTERNAL MODULE	RANGE <sup>2)</sup>		RESOLUTION	1 YEAR UNCERTAINTY ( $\pm$ ) <sup>1)</sup>
EXT200mC-s	$\pm 200$ mbar	$\pm 80$ iwc	0.01 mbar 0.01 iwc	0.05% RDG + 0.05% FS
EXT2C-s	-1...2 bar	-14.5...30 psi	0.0001 bar 0.001 psi	0.05% FS
EXT20C-s	-1...20 bar	-14.5...300 psi	0.001 bar 0.01 psi	0.05% FS
EXT160-s	0...160 bar	0...2400 psi	0.01 bar 0.1 psi	0.05% FS

## EXTERNAL PRESSURE MODULES (EXT) HIGH ACCURACY

MODULE	RANGE <sup>2)</sup>		1 YEAR UNCERTAINTY ( $\pm$ ) <sup>1)</sup>
Barometric	800...1200 mbar abs	23.6...35.4 inHg a	0.5 mbar (0.015 inHg)
EXT10mD	$\pm 10$ mbar differential	$\pm 4$ iwc differential	0.05% Span + 0.1% RDG
EXT100m	0...100 mbar gauge	0...40 iwc	0.025% FS + 0.025% RDG
EXT400mC	$\pm 400$ mbar	$\pm 160$ iwc	0.02% FS + 0.025% RDG
EXT1C	$\pm 1$ bar	-14.5...15 psi	0.015% FS + 0.025% RDG
EXT2C	-1...2 bar	-14.5...30 psi	0.01% FS + 0.025% RDG
EXT6C	-1...6 bar	-14.5...90 psi	0.01% FS + 0.025% RDG
EXT20C	-1...20 bar	-14.5...300 psi	0.01% FS + 0.025% RDG
EXT60	0...60 bar	0...900 psi	0.01% FS + 0.025% RDG
EXT100	0...100 bar	0...1500 psi	0.01% FS + 0.025% RDG
EXT160	0...160 bar	0...2400 psi	0.01% FS + 0.025% RDG
EXT250	0...250 bar	0...3700 psi	0.015% FS + 0.025% RDG
EXT600	0...600 bar	0...9000 psi	0.015% FS + 0.025% RDG
EXT1000	0...1000 bar	0...15000 psi	0.015% FS + 0.025% RDG

1) Uncertainty includes reference standard uncertainty, hysteresis, non-linearity, repeatability and typical long-term stability for the mentioned period (k=2).

2) The internal pressure module's range may also be displayed in absolute pressure if a barometric module is used.

3) The MC4 calibrator can hold one internal pressure module and the barometric option.

All external pressure modules (EXT) are also compatible with Beamex MC2, MC5, MC5P and MC6 calibrators.

## mV MEASUREMENT (T/C-TERMINALS) –25... 150 mV

RANGE	RESOLUTION	1 YEAR UNCERTAINTY(±) <sup>1)</sup>
–25... 150 mV	0.001 mV	0.02% RDG + 4 µV

FEATURE	SPECIFICATION
Temperature coefficient	< ±0.0015% RDG / °C outside of 18...28 °C < ±0.0008% RDG / °F outside of 64.4...82.4°F
Input impedance	> 10 MΩ
Supported units	V, mV, µV
Display update rate	3 / second

## mV GENERATION (T/C-TERMINALS) –25... 150 mV

RANGE	RESOLUTION	1 YEAR UNCERTAINTY (±) <sup>1)</sup>
–25... 150 mV	0.001 mV	0.02% RDG + 4 µV

FEATURE	SPECIFICATION
Temperature coefficient	< ±0.0015% RDG / °C outside of 18...28 °C < ±0.0008% RDG / °F outside of 64.4...82.4°F
Maximum load current	5 mA
Load effect	< 5µV/mA
Supported units	V, mV, µV

46

## VOLTAGE GENERATION –3... 12 V

RANGE	RESOLUTION	1 YEAR UNCERTAINTY (±) <sup>1)</sup>
±0.25 V	0.01 mV	0.02% RDG + 0.1 mV
–3...–0.25 V	0.1 mV	0.02% RDG + 0.1 mV
0.25... 12 V	0.1 mV	0.02% RDG + 0.1 mV

FEATURE	SPECIFICATION
Temperature coefficient	< ±0.0015% RDG / °C outside of 18...28 °C < ±0.0008% RDG / °F outside of 64.4...82.4°F
Maximum load current	5 mA
Load effect	< 50 µV/mA
Supported units	V, mV, µV

## mA GENERATION (SOURCE/SINK) 0... 25 mA

RANGE	RESOLUTION	1 YEAR UNCERTAINTY (±) <sup>1)</sup>
0... 25 mA	0.0001 mA	0.02% RDG + 1.5 µA

FEATURE	SPECIFICATION
Temperature coefficient	< ±0.0015% RDG / °C outside of 18...28 °C < ±0.0008% RDG / °F outside of 64.4...82.4°F
Max load impedance (source)	750 Ω (0...20 mA), 600 Ω (20...25 mA)
Max loop voltage (sink)	60 V
Supported units	mA, µA

1) Uncertainty includes reference standard uncertainty, hysteresis, non-linearity, repeatability and typical long-term stability for the mentioned period (k=2).

## RESISTANCE MEASUREMENT 0...4000 Ω

RANGE	RESOLUTION	1 YEAR UNCERTAINTY (±) <sup>(1)</sup>
0...250 Ω	1 mΩ	4-wire connection: 0.02% RDG + 3.5 mΩ 3-wire connection: 0.02% RDG + 13.5 mΩ
250...2650 Ω	10 mΩ	
2650...4000 Ω	100 mΩ	

FEATURE	SPECIFICATION
Temperature coefficient	< ±0.0015% RDG / °C outside of 18...28 °C < ±0.0008% RDG / °F outside of 64.4...82.4°F
Measurement current	Pulsed, bi-directional 1 mA (0...500 Ω), 0.2 mA (>500 Ω)
Supported units	Ω, kΩ
Display update rate	3 / second

## RESISTANCE SIMULATION 0...4000 Ω

RANGE	RESOLUTION	1 YEAR UNCERTAINTY (±) <sup>(1)</sup>
0...400 Ω	10 mΩ	0.04% RDG or 30 mΩ (whichever is greater)
400...4000 Ω	100 mΩ	0.04% RDG or 30 mΩ (whichever is greater)

FEATURE	SPECIFICATION
Temperature coefficient	< ±0.0015% RDG / °C outside of 18...28 °C < ±0.0008% RDG / °F outside of 64.4...82.4°F
Maximum resistance excitation current	5 mA (0...650 Ω) $I_{exc} \times R_{sim} < 3.25 \text{ V}$ (650...4000 Ω)
Settling time (pulsed currents)	1 ms
Supported units	Ω, kΩ

Specification valid with an excitation current >0.2 mA (0...400 Ω), >0.1 mA (400...4000 Ω).

47

## FREQUENCY GENERATION 0.0005...10 000 Hz

RANGE	RESOLUTION	1 YEAR UNCERTAINTY (±) <sup>(1)</sup>
0.0005...0.5 Hz	0.000001 Hz	0.01% RDG
0.5...5 Hz	0.00001 Hz	0.01% RDG
5...50 Hz	0.0001 Hz	0.01% RDG
50...500 Hz	0.001 Hz	0.01% RDG
500...5000 Hz	0.01 Hz	0.01% RDG
5000...10000 Hz	0.1 Hz	0.01% RDG

FEATURE	SPECIFICATION
Temperature coefficient	Specification valid from -10 to 50 °C (14...122°F)
Maximum load current	5 mA
Output amplitude positive square wave	0...12 Vpp ±(0.2 V+5%)
Output amplitude symmetric square wave	0...6 Vpp ±(0.2 V+5%)
Duty cycle	1...99% (0.0009...500 Hz), high / low time: min 25µs, max 1165 s
Supported units	Hz, kHz, cph, cpm, 1/Hz (s), 1/kHz (ms), 1/MHz (µs)
Jitter	< 0.28 µs

## PULSE GENERATION 0...9 999 999 PULSES

FEATURE	SPECIFICATION
Range	0 to 9 999 999 pulses
Resolution	1 pulse
Maximum load current	5 mA
Output amplitude positive pulse	0...12 Vpp ±(0.2 V+5%)
Output amplitude symmetric pulse	0...6 Vpp ±(0.2 V+5%)
Pulse frequency	0.0005...10 000 Hz
Duty cycle	1...99% (0.0009...500 Hz), high / low time: min 25µs, max 1165 s

<sup>(1)</sup> Uncertainty includes reference standard uncertainty, hysteresis, non-linearity, repeatability and typical long-term stability for the mentioned period. (k=2).

# THERMOCOUPLE MEASUREMENT AND SIMULATION

## Thermocouple types available as standard

TYPE	RANGE (°C)	RANGE (°C)	1 YEAR UNCERTAINTY (±) <sup>1)</sup>
B <sup>2)</sup>	0...1820	0...200	<sup>3)</sup>
		200...500	2.0 °C
		500...800	0.8 °C
		800...1820	0.6 °C
R <sup>2)</sup>	-50...1768	-50...0	1.0 °C
		0...50	0.7 °C
		50...1400	0.5 °C
		1400...1768	0.6 °C
S <sup>2)</sup>	-50...1768	-50...0	1.0 °C
		0...50	0.7 °C
		50...1500	0.6 °C
		1500...1768	0.7 °C
E <sup>2)</sup>	-270...1000	-270...-200	<sup>3)</sup>
		-200...0	0.07 °C + 0.08% RDG
		0...600	0.07 °C + 0.015% RDG
		600...1000	0.026% RDG
J <sup>2)</sup>	-210...1200	-210...-200	<sup>3)</sup>
		-200...0	0.08 °C + 0.07% RDG
		0...1200	0.08 °C + 0.02% RDG
K <sup>2)</sup>	-270...1372	-270...-200	<sup>3)</sup>
		-200...0	0.1 °C + 0.1% RDG
		0...1000	0.1 °C + 0.02% RDG
		1000...1372	0.03% RDG
N <sup>2)</sup>	-270...1300	-270...-200	<sup>3)</sup>
		-200...-100	0.2% RDG
		-100...0	0.15 °C + 0.05% RDG
		0...750	0.15 °C + 0.01% RDG
		750...1300	0.03% RDG
T <sup>2)</sup>	-270...400	-270...-250	<sup>3)</sup>
		-250...-200	0.7 °C
		-200...0	0.1 °C + 0.1% RDG
		0...400	0.1 °C + 0.01% RDG
U <sup>4)</sup>	-200...600	-200...0	0.15 °C + 0.1% RDG
		0...600	0.15 °C + 0.01% RDG
L <sup>4)</sup>	-200...900	-200...0	0.13 °C + 0.07% RDG
		0...900	0.13 °C + 0.02% RDG
C <sup>5)</sup>	0...2315	0...900	0.4 °C
		900...2000	0.045% RDG
		2000...2315	1.2 °C
G <sup>6)</sup>	0...2315	0...70	<sup>3)</sup>
		70...200	1.0 °C
		200...1600	0.5 °C
		1600...2000	0.7 °C
		2000...2315	1.0 °C
D <sup>5)</sup>	0...2315	0...1000	0.4 °C
		1000...2000	0.04% RDG
		2000...2315	1.2 °C

FEATURE	MEASUREMENT	SIMULATION
Resolution	0.01 °C	0.01 °C
Temperature coefficient	< ±0.0015% of thermovoltage / °C outside of 18...28 °C < ±0.0008% of thermovoltage / °F outside of 64.4...82.4°F	< ±0.0015% of thermovoltage / °C outside of 18...28 °C < ±0.0008% of thermovoltage / °F outside of 64.4...82.4°F
Input impedance	>10 MΩ	–
Supported units	°C, °F, K	°C, °F, K
Display update rate	3 / second	–
Maximum load current	–	5 mA
Load effect	–	< 5 µV/mA



## INTERNAL REFERENCE JUNCTION

RANGE (°C)	1 YEAR UNCERTAINTY
-10...50 °C	±0.25 °C

- 1) Uncertainty includes reference standard uncertainty, hysteresis, non-linearity, repeatability and typical long-term stability for the mentioned period (k=2).  
Uncertainty does not include reference junction uncertainty.
- 2) IEC 584, NIST MN 175, BS 4937, ANSI MC96.1
- 3) ±0.02% of thermovoltage + 4 µV
- 4) DIN 43710
- 5) ASTM E 988 - 96
- 6) ASTM E 1751 - 95e1

## RTD MEASUREMENT AND SIMULATION

SENSOR TYPE	RANGE	RESOLUTION	MEASUREMENT 1 YEAR UNCERTAINTY (±) <sup>1)</sup>	SIMULATION 1 YEAR UNCERTAINTY (±) <sup>1) 2)</sup>
Pt 50...1000	-200...0 °C 0...850 °C	0.01 °C	0.06 °C 0.06 °C + 0.025% RDG	0.10 °C 0.10 °C + 0.025% RDG
Ni 100	-60...180 °C	0.01 °C	0.06 °C	0.12 °C
Ni 120	-80...260 °C	0.01 °C	0.06 °C	0.12 °C
Cu10	-200...260 °C	0.01 °C	0.2 °C	0.8 °C

FEATURE	MEASUREMENT	SIMULATION
Temperature coefficient	< ±0.0015% of resistance / °C outside of 18...28 °C < ±0.0008% of resistance / °F outside of 64.4...82.4°F	< ±0.0015% of resistance / °C outside of 18...28 °C < ±0.0008% of resistance / °F outside of 64.4...82.4°F
Measurement current	Pulsed, 1 mA (0..500 Ω), 0.2 mA (>500 Ω)	–
Maximum resistance excitation current	–	5 mA (0...650 Ω) I <sub>exc</sub> × R <sub>sim</sub> < 3.25 V (650...4000 Ω)
Supported units	°C, °F, K	°C, °F, K
Display update rate	3 / second	–
Settling time (pulsed currents)	1 ms	–

RTD TYPES AVAILABLE AS STANDARD				
Pt50 (385)	Pt400 (385)	Pt100 (3926)	Pt100 (3923)	Cu10 (427)
Pt100 (385)	Pt500 (385)	Pt100 (391)	Ni100 (618)	
Pt200 (385)	Pt1000 (385)	Pt100 (375)	Ni120 (672)	

- 1) Uncertainty includes reference standard uncertainty, hysteresis, non-linearity, repeatability and typical long-term stability for the mentioned period (k=2).
- 2) Specification valid with an excitation current >0.2 mA (0...400 Ω), >0.1 mA (400...4000 Ω).

MC4 supports Callendar van Dusen correction coefficients for PRT sensors to compensate sensor error.

## STANDARD ACCESSORIES

- User guide
- Accredited calibration certificate
- Internal rechargeable NiMH battery pack + battery charger
- Test leads and clips
- USB cable
- Adapter pressure connector – from G1/8" female to G 1/8" male  
with 60° internal cone (included in models with internal pressure module)

## OPTIONAL ACCESSORIES

- Pressure T-hose
- Soft carrying case
- Connection cable for external pressure modules
- Calibration hand-pumps

# Beamex MC4

## DOCUMENTING PROCESS CALIBRATOR

50

The Beamex MC4 is a documenting process calibrator. Instrument data can be sent from a computer to the MC4, and calibration results can be uploaded from the MC4 to a computer using the Beamex CMX calibration software. Being a multifunctional calibrator, the MC4 is suitable for calibrating various process parameters, such as pressure, temperature and electrical signals. High accuracy is one of the important features of the MC4. A standard feature of the MC4 includes an accredited calibration certificate as proof of its accuracy.

### Communication with calibration software

Using the MC4 together with calibration software provides you with a complete documenting calibration system that produces calibration certificates automatically.

### All-in-one functionality

The MC4 is a versatile calibrator with many different functions. There's no need to take several different measurement devices to the field – MC4 does the job.

### Accuracy guaranteed

The MC4 is a highly accurate process calibrator. As a proof of this, each calibrator is delivered with a traceable, accredited calibration certificate.

### Calibration is quick and easy

The large graphical display, menu-based multilingual user interface, and full numerical keyboard make the MC4 quick and easy to use.



### Main features

- ▶ Automated and documented calibrations quickly and easily
- ▶ Calibration capabilities for pressure, temperature, electrical and frequency signals
- ▶ Compact size and design
- ▶ Documenting – communicates with Beamex calibration software



# Beamex MC2

HAND-HELD PROCESS CALIBRATOR



78977348759834759833  
87898654546546  
78977348759834759833  
655387875684653403

51

Practicality in calibration



**beamex**  
A BETTER WAY TO CALIBRATE

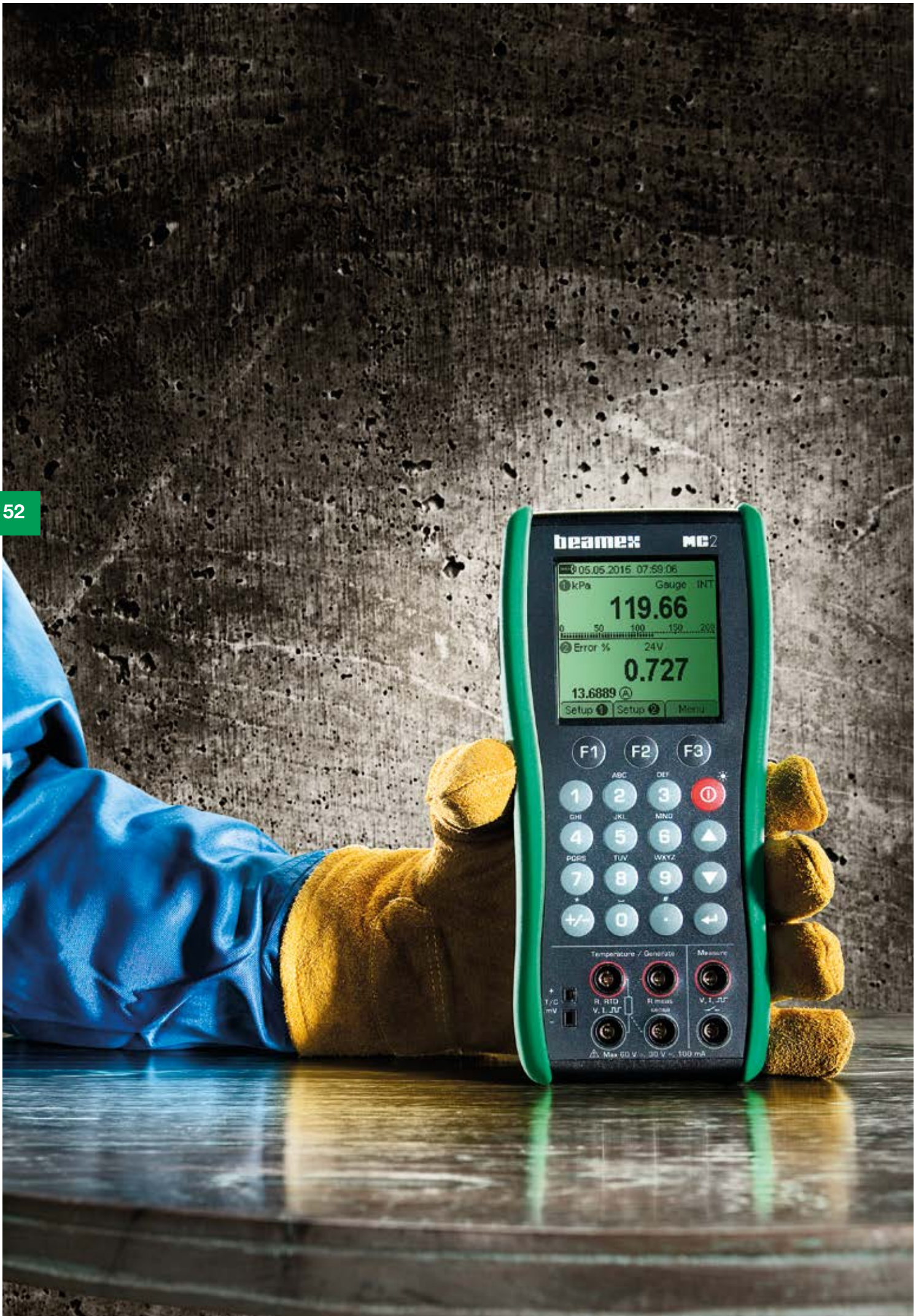

beamex MC2

05.05.2016 07:59:06  
kPa Gauge INT  
**119.66**  
Error % 24V  
**0.727**  
13.6889 A  
Setup Setup Menu

F1 F2 F3  
1 2 3  
4 5 6  
7 8 9  
+/- 0

Temperature / Resistance Measure  
R, RTD V, I,  $\mu$ F  
Max 60 V ~ 30 V ~ 100 mA

# MC2: hand-held calibrator for field use

## Practicality in calibration

The MC2 is a compact and easy-to-use hand-held calibrator. It has a large graphical display, a menu-based interface and a full numerical keyboard. The MC2 represents the high, uncompromised quality standards of Beamex calibration equipment.

## Documenting calibrator – Go paperless

The Beamex MC2 is a documenting\* calibrator. This means that it saves calibration results in its memory and communicates with Beamex calibration software (CMX and LOGiCAL) for fully paperless flow of calibration data.

Using a documenting calibrator, there is no need for error prone manual entry of calibration results at any step of the calibration process. This saves you time and money, and improves the quality of calibration results.

*\* Since the firmware version 3.20 (released in March 2019) MC2 is a documenting calibrator. This is valid for MC2-MF and MC2-TE models with serial numbers greater than 13000.*

53

# The main features of MC2

## Documenting calibrator

The Beamex MC2 is a documenting calibrator and is part of the Beamex Integrated Calibration Solution.

## Compact and user-friendly

The MC2 is a compact, lightweight portable calibrator with large graphical display, multilingual interface and full numerical keyboard. Calibration is quick and simple.

## Accuracy guaranteed

The MC2 is delivered with a traceable, accredited calibration certificate.

## Safe and robust field calibrator

The MC2 with impact protectors and membrane keyboard is robust and made for tough use.

## Wide range of configuration possibilities

The MC2 provides a number of configuration possibilities, such as internal and external pressure modules.



# The MC2 specifications



54

## FEATURES

- Internal pressure module
- Connection for external pressure modules
- Current measurement (with internal and external supply)
- Voltage measurement
- Frequency measurement
- Pulse counting
- Switch sensing
- Internal HART compatible 24 VDC loop supply
- Current generation (with internal and external supply)
- Voltage generation
- Frequency generation
- Pulse generation
- mV measurement / simulation
- Resistance measurement / simulation
- RTD measurement / simulation
- TC measurement / simulation



# The MC2 general specifications

## GENERAL SPECIFICATIONS

GENERAL	MC2
Display	60 mm x 60 mm (2.36" x 2.36"), 160 x 160 pixels backlit LCD
Weight	720...830 g (1.59...1.83 lbs)
Dimensions	215 mm (8.5") x 102 mm (4") x 49 mm (1.9") (d/w/h)
Keyboard	Membrane keyboard
Battery type	Rechargeable NiMH, 4000 mAh, 3.6V DC
Charging time	5 hours
Charger supply	100...240 VAC, 50-60 Hz
Battery operation	13...24 hours in measurement mode, back light off. 8...12 hours when sourcing an average of 12 mA to loop, with back light on.
Operating temperature	-10...50 °C (14...122°F)
Operating temperature when charging batteries	0...35 °C (32...95°F)
Storage temperature	-20 to 60 °C (-4 to 140°F)
Humidity	0 to 80% R.H. non condensing
Warmup time	Specifications valid after a 5 minute warmup period.
Max. input voltage	30 V AC, 60 V DC
Safety	Directive 2014/35/EU, EN 61010-1:2010
EMC	Directive 2014/30/EU, EN 61362-1:2013
RoHS compliance	RoHS II Directive 2011/65/EU
Warranty	Standard: 2 years for MC2; 1 year for battery pack. <sup>(1)</sup>

1) Warranty extension programs are also available.

55

## VOLTAGE MEASUREMENT -1...60 V DC

RANGE	RESOLUTION	1 YEAR UNCERTAINTY ( $\pm$ ) <sup>(1)</sup>
$\pm 0.25$ V	0.001mV	0.02% RDG + 5 $\mu$ V
$\pm(0.25...1)$ V	0.01 mV	0.02% RDG + 5 $\mu$ V
1...25 V	0.1 mV	0.02% RDG + 0.25 mV
25...60 V	1 mV	0.02% RDG + 0.25 mV

FEATURE	SPECIFICATION
Temperature coefficient	< $\pm 0.0015\%$ RDG / °C outside of 18...28 °C < $\pm 0.0008\%$ RDG / °F outside of 64.4...82.4°F
Input impedance	>1 M $\Omega$
Supported units	V, mV, $\mu$ V
Display update rate	3 / second

## mA MEASUREMENT $\pm 100$ mA

RANGE	RESOLUTION	1 YEAR UNCERTAINTY ( $\pm$ ) <sup>(1)</sup>
$\pm 25$ mA	0.0001 mA	0.02% RDG + 1.5 $\mu$ A
$\pm(25...100)$ mA	0.001 mA	0.02% RDG + 1.5 $\mu$ A

FEATURE	SPECIFICATION
Temperature coefficient	< $\pm 0.0015\%$ RDG / °C outside of 18...28 °C < $\pm 0.0008\%$ RDG / °F outside of 64.4...82.4°F
Input impedance	< 7.5 $\Omega$
Supported units	mA, $\mu$ A
Display update rate	3 / second

## LOOP SUPPLY

FEATURE	SPECIFICATION
Maximum output current	> 25 mA, short circuit protected
Output voltage	24 V $\pm$ 10%
Output impedance in HART compatible mode	300 $\Omega$ $\pm$ 20%

1) Uncertainty includes reference standard uncertainty, hysteresis, non-linearity, repeatability and typical long-term stability for the mentioned period (k=2).

# Electrical measurements

## FREQUENCY MEASUREMENT 0.0027...50 000 Hz

RANGE	RESOLUTION	1 YEAR UNCERTAINTY ( $\pm$ ) <sup>1)</sup>
0.0027...0.5 Hz	0.000001 Hz	0.01% RDG
0.5...5 Hz	0.00001 Hz	0.01% RDG
5...50 Hz	0.0001 Hz	0.01% RDG
50...500 Hz	0.001 Hz	0.01% RDG
500...5000 Hz	0.01 Hz	0.01% RDG
5000...50000 Hz	0.1 Hz	0.01% RDG

FEATURE	SPECIFICATION
Temperature coefficient	Specification valid from -10 to 50 °C (14...122°F)
Input impedance	> 1 M $\Omega$
Trigger level	-1...14 V in 1 V steps and open collector inputs
Minimum signal amplitude	2 Vpp (< 10 kHz), 3 Vpp (10...50 kHz)
Supported units	Hz, kHz, cph, cpm, 1/Hz (s), 1/kHz (ms), 1/MHz ( $\mu$ s)
Gate period	267 ms + 1 signal period

1) Uncertainty includes reference standard uncertainty, hysteresis, non-linearity, repeatability and typical long-term stability for the mentioned period (k=2).

56

## PULSE COUNTING 0...9 999 999 PULSES

FEATURE	SPECIFICATION
Range	0 to 9 999 999 pulses
Input impedance	> 1 M $\Omega$
Trigger level	-1...14 V in 1 V steps and open collector inputs
Minimum signal amplitude	2 Vpp (pulse length > 50 $\mu$ s), 3 Vpp (pulse length 10...50 $\mu$ s)

## SWITCH TEST

FEATURE	SPECIFICATION	MC2
Potential free contacts	Test voltage (trigger level)	3 V, 0.13 mA (1 V) or 24 V, 35 mA (2 V)
Voltage level detection	Trigger level Input impedance	-1...14 V in 1 V steps > 1 M $\Omega$





# Pressure measurement

## INTERNAL PRESSURE MODULES (IPM)

INTERNAL MODULE <sup>(3)</sup>	UNIT	RANGE <sup>(2)</sup>	RESOLUTION	1 YEAR UNCERTAINTY (±) <sup>(1)</sup>
IPM200mC	kPa	±20	0.001	0.05% RDG + 0.05% FS
	mbar	±200	0.01	
	iwc	±80	0.01	
IPM2C	kPa	-100 to 200	0.01	0.05% FS
	bar	-1 to 2	0.0001	
	psi	-14.5 to 30	0.001	
IPM20C	kPa	-100 to 2000	0.1	0.05% FS
	bar	-1 to 20	0.001	
	psi	-14.5 to 300	0.01	
IPM160	MPa	0...16	0.001	0.05% FS
	bar	0...160	0.01	
	psi	0...2400	0.1	
Barometric option	Also enables absolute pressure measurement for the above pressure inputs. When using the barometric option, add 0.1 kPa (0.0146 psi) uncertainty for absolute pressure measurement.			

FEATURE	SPECIFICATION
Temperature coefficient	< ±0.001% RDG / °C outside 15...35 °C. < ±0.0006% RDG / °F outside 59...95°F
Maximum overpressure	2 × Range
Pressure port	G 1/8" female with G 1/8" male (ISO 228/1) 60° internal cone adapter IPM160: G 1/8" female
Media compatibility	Wetted parts: AISI316 stainless steel, Nitrile rubber
Supported pressure units	Pa, hPa, kPa, MPa, mbar, bar, lbf/ft <sup>2</sup> , psi, ozf/in <sup>2</sup> , gf/cm <sup>2</sup> , kgf/cm <sup>2</sup> , kgf/m <sup>2</sup> , kp/cm <sup>2</sup> , at, mmH <sub>2</sub> O, cmH <sub>2</sub> O, mH <sub>2</sub> O, iwc, ftH <sub>2</sub> O, mmHg, cmHg, mHg, inHg, mmHg(0 °C), inHg(0 °C), mmH <sub>2</sub> O(4 °C; 60°F; 68°F/20 °C), cmH <sub>2</sub> O(4 °C; 60°F; 68°F/20 °C), inH <sub>2</sub> O(4 °C; 60°F; 68°F/20 °C), ftH <sub>2</sub> O(4 °C; 60°F; 68°F/20 °C), torr, atm, + four (4) user-configurable units
Display update rate	2.5 / second

57

## EXTERNAL PRESSURE MODULES (EXT) STANDARD ACCURACY

MODULE	RANGE <sup>(2)</sup>	RESOLUTION	1 YEAR UNCERTAINTY (±) <sup>(1)</sup>
EXT200mC-s	±200 mbar	±80 iwc 0.01 mbar 0.01 iwc	0.05% RDG + 0.05% FS
EXT2C-s	-1...2 bar	-14.5...30 psi 0.0001 bar 0.001 psi	0.05% FS
EXT20C-s	-1...20 bar	-14.5...300 psi 0.001 bar 0.01 psi	0.05% FS
EXT160-s	0...160 bar	0...2400 psi 0.01 bar 0.1 psi	0.05% FS

## EXTERNAL PRESSURE MODULES (EXT) HIGH ACCURACY

MODULE	RANGE <sup>(2)</sup>	1 YEAR UNCERTAINTY (±) <sup>(1)</sup>
Barometric	800...1200 mbar abs 23.6...35.4 inHg a	0.5 mbar (0.015 inHg)
EXT10mD	±10 mbar differential ±4 iwc differential	0.1% RDG + 0.05% Span
EXT100m	0...100 mbar gauge 0...40 iwc	0.025% RDG + 0.025% FS
EXT400mC	±400 mbar ±160 iwc	0.025% RDG + 0.02% FS
EXT1C	±1 bar -14.5...15 psi	0.025% RDG + 0.015% FS
EXT2C	-1...2 bar -14.5...30 psi	0.025% RDG + 0.01% FS
EXT6C	-1...6 bar -14.5...90 psi	0.025% RDG + 0.01% FS
EXT20C	-1...20 bar -14.5...300 psi	0.025% RDG + 0.01% FS
EXT60	0...60 bar 0...900 psi	0.025% RDG + 0.01% FS
EXT100	0...100 bar 0...1500 psi	0.025% RDG + 0.01% FS
EXT160	0...160 bar 0...2400 psi	0.025% RDG + 0.01% FS
EXT250	0...250 bar 0...3700 psi	0.025% RDG + 0.015% FS
EXT600	0...600 bar 0...9000 psi	0.025% RDG + 0.015% FS
EXT1000	0...1000 bar 0...15000 psi	0.025% RDG + 0.015% FS

1) Uncertainty includes reference standard uncertainty, hysteresis, non-linearity, repeatability and typical long-term stability for the mentioned period (k=2).

2) The internal pressure module's range may also be displayed in absolute pressure if a barometric module is used.

3) The MC2 calibrator can hold one internal pressure module and the barometric option.

All external pressure modules (EXT) are also compatible with Beamex MC4, MC5 and MC6 calibrators.

# Electrical generation, measurement and simulation

## mV MEASUREMENT (T/C-TERMINALS) –25...150 mV

RANGE	RESOLUTION	1 YEAR UNCERTAINTY (±) <sup>(1)</sup>
–25...150 mV	0.001 mV	0.02% RDG + 4 µV

FEATURE	SPECIFICATION
Temperature coefficient	< ±0.0015% RDG / °C outside of 18...28 °C < ±0.0008% RDG / °F outside of 64.4...82.4°F
Input impedance	> 10 MΩ
Supported units	V, mV, µV
Display update rate	3 / second

## mV GENERATION (T/C-TERMINALS) –25...150 mV

RANGE	RESOLUTION	1 YEAR UNCERTAINTY (±) <sup>(1)</sup>
–25...150 mV	0.001 mV	0.02% RDG + 4 µV

FEATURE	SPECIFICATION
Temperature coefficient	< ±0.0015% RDG / °C outside of 18...28 °C < ±0.0008% RDG / °F outside of 64.4...82.4°F
Maximum load current	5 mA
Load effect	< 5 µV/mA
Supported units	V, mV, µV

58

## VOLTAGE GENERATION –3...12 V

RANGE	RESOLUTION	1 YEAR UNCERTAINTY (±) <sup>(1)</sup>
±0.25 V	0.01 mV	0.02% RDG + 0.1 mV
–3...–0.25 V	0.1 mV	0.02% RDG + 0.1 mV
0.25...12 V	0.1 mV	0.02% RDG + 0.1 mV

FEATURE	SPECIFICATION
Temperature coefficient	< ±0.0015% RDG / °C outside of 18...28 °C < ±0.0008% RDG / °F outside of 64.4...82.4°F
Maximum load current	5 mA
Load effect	< 50 µV/mA
Supported units	V, mV, µV

## mA GENERATION (SOURCE/SINK) 0...25 mA

RANGE	RESOLUTION	1 YEAR UNCERTAINTY (±) <sup>(1)</sup>
0...25 mA	0.0001 mA	0.02% RDG + 1.5 µA

FEATURE	SPECIFICATION
Temperature coefficient	< ±0.0015% RDG / °C outside of 18...28 °C < ±0.0008% RDG / °F outside of 64.4...82.4°F
Max load impedance (source)	750 Ω (0...20 mA), 600 Ω (20...25 mA)
Max loop voltage (sink)	60 V
Supported units	mA, µA

1) Uncertainty includes reference standard uncertainty, hysteresis, non-linearity, repeatability and typical long-term stability for the mentioned period (k=2).

## RESISTANCE MEASUREMENT 0...4000 Ω

RANGE	RESOLUTION	1 YEAR UNCERTAINTY (±) <sup>(1)</sup>
0...250 Ω	1 mΩ	4-wire connection: 0.02% RDG + 3.5 mΩ 3-wire connection: 0.02% RDG + 13.5 mΩ
250...2650 Ω	10 mΩ	
2650...4000 Ω	100 mΩ	

FEATURE	SPECIFICATION
Temperature coefficient	< ±0.0015% RDG / °C outside of 18...28 °C < ±0.0008% RDG / °F outside of 64.4...82.4°F
Measurement current	Pulsed, bi-directional 1 mA (0..500 Ω), 0.2 mA (>500 Ω)
Supported units	Ω, kΩ
Display update rate	3 / second

## RESISTANCE SIMULATION 0...4000 Ω

RANGE	RESOLUTION	1 YEAR UNCERTAINTY (±) <sup>(1)</sup>
0...400 Ω	10 mΩ	0.04% RDG or 30 mΩ (Whichever is greater)
400...4000 Ω	100 mΩ	0.04% RDG or 30 mΩ (Whichever is greater)

FEATURE	SPECIFICATION
Temperature coefficient	< ±0.0015% RDG / °C outside of 18...28 °C < ±0.0008% RDG / °F outside of 64.4...82.4°F
Maximum resistance excitation current	5 mA (0...650 Ω) $I_{exc} \times R_{sim} < 3.25 \text{ V}$ (650...4000 Ω)
Settling time (pulsed currents)	1 ms
Supported units	Ω, kΩ

59

## FREQUENCY GENERATION 0.0005...10 000 Hz

RANGE	RESOLUTION	1 YEAR UNCERTAINTY (±) <sup>(1)</sup>
0.0005...0.5 Hz	0.000001 Hz	0.01% RDG
0.5...5 Hz	0.00001 Hz	0.01% RDG
5...50 Hz	0.0001 Hz	0.01% RDG
50...500 Hz	0.001 Hz	0.01% RDG
500...5000 Hz	0.01 Hz	0.01% RDG
5000...10000 Hz	0.1 Hz	0.01% RDG

FEATURE	SPECIFICATION
Temperature coefficient	Specification valid from -10 to 50 °C (14...122°F)
Maximum load current	5 mA
Output amplitude positive square wave	0...12 Vpp ±(0.2 V+5%)
Output amplitude symmetric square wave	0...6 Vpp ±(0.2 V+5%)
Duty cycle	1...99% (0.0009...500 Hz), high / low time: min 25µs, max 1165 s
Supported units	Hz, kHz, cph, cpm, 1/Hz (s), 1/kHz (ms), 1/MHz (µs)
Jitter	< 0.28 µs

## PULSE GENERATION 0...9 999 999 PULSES

FEATURE	SPECIFICATION
Range	0 to 9 999 999 pulses
Resolution	1 pulse
Maximum load current	5 mA
Output amplitude positive pulse	0...12 Vpp ±(0.2 V+5%)
Output amplitude symmetric pulse	0...6 Vpp ±(0.2 V+5%)
Pulse frequency	0.0005...10 000 Hz
Duty cycle	1...99% (0.0009...500 Hz), high / low time: min 25µs, max 1165 s

1) Uncertainty includes reference standard uncertainty, hysteresis, non-linearity, repeatability and typical long-term stability for the mentioned period (k=2).

# THERMOCOUPLE MEASUREMENT AND SIMULATION

## Thermocouple types available as standard

TYPE	RANGE (°C)	RANGE (°C)	1 YEAR UNCERTAINTY (±) <sup>(1)</sup>
B <sup>(2)</sup>	0...1820	0...200	<sup>(3)</sup>
		200...400	2.0 °C
		400...1820	1.0 °C
R <sup>(2)</sup>	-50...1768	-50...0	1.0 °C
		0...100	0.8 °C
		100...1768	0.6 °C
S <sup>(2)</sup>	-50...1768	-50...0	1.0 °C
		0...1768	0.7 °C
E <sup>(2)</sup>	-270...1000	-270...-200 -200...1000	<sup>(3)</sup> 0.25 °C
J <sup>(2)</sup>	-210...1200	-210...1200	0.3 °C
K <sup>(2)</sup>	-270...1372	-270...-200	<sup>(3)</sup>
		-200...1000	0.3 °C
		1000...1372	0.4 °C
N <sup>(2)</sup>	-270...1300	-270...-200	<sup>(3)</sup>
		-200...1300	0.4 °C
T <sup>(2)</sup>	-270...400	-270...-200	<sup>(3)</sup>
		-200...-100	0.3 °C
		-100...400	0.2 °C
U <sup>(4)</sup>	-200...600	-200...-100	0.3 °C
		-100...600	0.2 °C
L <sup>(4)</sup>	-200...900	-200...900	0.25 °C
C <sup>(5)</sup>	0...2315	0...1000	0.4 °C
		1000...2000	0.8 °C
		2000...2315	1.2 °C
G <sup>(6)</sup>	0...2315	0...100	<sup>(3)</sup>
		100...2315	1.0 °C
D <sup>(5)</sup>	0...2315	0...1000	0.4 °C
		1000...2000	0.8 °C
		2000...2315	1.2 °C

FEATURE	MEASUREMENT	SIMULATION
Resolution	0.01 °C	0.01 °C
Temperature coefficient	< ±0.0015% of thermovoltage / °C outside of 18...28 °C < ±0.0008% of thermovoltage / °F outside of 64.4 ... 82.4°F	< ±0.0015% of thermovoltage / °C outside of 18...28 °C < ±0.0008% of thermovoltage / °F outside of 64.4 ... 82.4°F
Input impedance	>10 MΩ	–
Supported units	°C, °F, K	°C, °F, K
Display update rate	3 / second	–
Maximum load current	–	5 mA
Load effect	–	< 5 µV/mA

## INTERNAL REFERENCE JUNCTION

RANGE (°C)	1 YEAR UNCERTAINTY
-10...50 °C	±0.25 °C

1) Uncertainty includes reference standard uncertainty, hysteresis, non-linearity, repeatability and typical long-term stability for the mentioned period (k=2).

Uncertainty does not include reference junction uncertainty.

2) IEC 584, NIST MN 175, BS 4937, ANSI MC96.1

3) ±0.02% of thermovoltage + 4 µV

4) DIN 43710

5) ASTM E 988 - 96

6) ASTM E 1751 - 95e1

## RTD MEASUREMENT AND SIMULATION

SENSOR TYPE	RANGE	RESOLUTION	MEASUREMENT 1 YEAR UNCERTAINTY ( $\pm$ ) 1	SIMULATION 1 YEAR UNCERTAINTY ( $\pm$ ) <sup>1) 2)</sup>
Pt 50 ... 1000	-200 ... 200 °C	0.01 °C	0.1 °C	0.15 °C
	200 ... 600 °C	0.01 °C	0.2 °C	0.25 °C
	600 ... 850 °C	0.01 °C	0.3 °C	0.35 °C
Ni 100	-60 ... 180 °C	0.01 °C	0.1 °C	0.15 °C
Ni 120	-80 ... 260 °C	0.01 °C	0.1 °C	0.15 °C
Cu10	-200 ... 260 °C	0.01 °C	0.2 °C	0.8 °C

FEATURE	MEASUREMENT	SIMULATION
Temperature coefficient	< $\pm 0.0015\%$ of resistance / °C outside of 18...28 °C < $\pm 0.0008\%$ of resistance / °F outside of 64.4 ... 82.4 °F	< $\pm 0.0015\%$ of thermovoltage / °C outside of 18...28 °C < $\pm 0.0008\%$ of thermovoltage / °F outside of 64.4 ... 82.4 °F
Maximum Resistance excitation current	–	5 mA (0 ... 650 $\Omega$ ) $I_{exc} \times R_{sim} < 3.25$ V (650 ... 4000 $\Omega$ )
Supported units	°C, °F, K	°C, °F, K
Display update rate	3 / second	–

RTD TYPES AVAILABLE AS STANDARD				
Pt50 (385)	Pt400 (385)	Pt100 (3926)	Pt100 (3923)	Cu10 (427)
Pt100 (385)	Pt500 (385)	Pt100 (391)	Ni100 (618)	
Pt200 (385)	Pt1000 (385)	Pt100 (375)	Ni120 (672)	

1) Uncertainty includes reference standard uncertainty, hysteresis, non-linearity, repeatability and typical long-term stability for the mentioned period. (k=2).

2) Specification valid with an excitation current >0.2 mA (0 ... 400  $\Omega$ ), >0.1 mA (400 ... 4000  $\Omega$ )

## STANDARD ACCESSORIES

- User guide
- Calibration certificate
- Internal rechargeable NiMH battery pack + battery charger
- Test leads and clips
- USB cable
- Adapter pressure connector – from G1/8" female to G 1/8" male with 60° internal cone (included in models with internal pressure module)

## OPTIONAL ACCESSORIES

- Pressure T-hose
- Soft carrying case
- Connection cable for external pressure modules
- Calibration handpumps

# Beamex MC2

## HAND-HELD PROCESS CALIBRATOR

62

The Beamex MC2 is a high-quality hand-held calibrator for field use. The MC2 is a compact and easy-to-use hand-held calibrator. It has a large graphical display, a menu-based interface and full numerical keyboard.

### Documenting calibrator

The Beamex MC2 is a documenting calibrator and is part of the Beamex Integrated Calibration Solution.

### Compact and user-friendly

The MC2 is a compact, lightweight portable calibrator with large graphical display, multilingual interface and full numerical keyboard. Calibration is quick and simple.

### Accuracy guaranteed

The calibrator is delivered with a traceable, accredited calibration certificate.

### Safe and robust field calibrator

The MC2 with impact protectors and membrane keyboard is robust and made for tough use.

### Wide range of configuration possibilities

The MC2 provides a number of configuration possibilities, such as internal and external pressure modules.



### Main features

- ▶ A practical hand-held documenting process calibrator
- ▶ Internal / external pressure modules
- ▶ Compact size and design
- ▶ User-friendly



# Beamex MC6-Ex

INTRINSICALLY SAFE ADVANCED FIELD CALIBRATOR AND COMMUNICATOR

79877348759834759833  
87984654546546  
79877348759834759833  
655387875684653403



63

The world's most accurate documenting calibrator and communicator for hazardous areas



**beamex**  
A BETTER WAY TO CALIBRATE

# Made for extreme environments





# MC6-Ex: designed for use in extreme environments

No other Ex-calibrator can outperform the MC6-Ex in terms of functionality and accuracy. The ATEX, IECEx and North American certified MC6-Ex is designed for use in potentially explosive environments, such as offshore and on-shore oil and gas platforms, oil refineries, chemical and petrochemical plants where inflammable gases may be present. It can also be used in the pharmaceutical industry, within energy production and gas processing industry.

With MC6-Ex no hot-work permits are needed nor additional safety equipment, such as gas detectors. The risk of harming other Ex equipment or damaging their safety protection circuits are limited. MC6-Ex is a very safe and easy choice when entering any hazardous zone, as it is approved for the tightest zone, Zone 0.

The MC6-Ex is an advanced, high-accuracy calibrator and communicator with outstanding functionality. It is a documenting, multifunction calibrator and communicator that offers calibration capabilities for pressure, temperature and various electrical

signals. It also contains a fieldbus communicator for HART, FOUNDATION Fieldbus and Profibus PA instruments.

The robust IP65-rated dust- and water-proof casing, ergonomic design and ease-of-use make it an ideal measurement device for field use. The smart battery pack is field replaceable NiMH and it can be charged either inside or outside the calibrator. The MC6-Ex is one device with five different operational modes, which means that it is fast and easy to use, and you can carry less equipment in the field. The operation modes are: meter, calibrator, documenting calibrator, data logger and fieldbus communicator.

In addition, the MC6-Ex communicates with Beamex LOGiCAL cloud-based calibration software and CMX calibration management software, enabling fully automated and paperless calibration and documentation. The MC6-Ex can also be part of the paperless integration to the customer's own ERP system.



## Main features of MC6-Ex

### Accuracy

High-accuracy, advanced field calibrator and communicator.

### Usability

Combines advanced functionality with ease-of-use.

### Safety

Approved for Ex ia IIC T4 Ga – classification.

### Versatility

Versatile functionality beyond traditional calibration applications.

### Communicator

Full multi-bus communicator for HART, FOUNDATION Fieldbus and Profibus PA instruments.

### Internal loop supply

MC6-Ex features an internal loop supply for transmitters, so no additional supplies are needed.

### Integration

Automates calibration procedures for paperless calibration management.





# Additional features

## Accuracy guaranteed

The MC6-Ex is probably the most accurate advanced process calibrator and communicator available. As proof of this, each MC6-Ex calibrator is delivered with a traceable, accredited calibration certificate as standard. The certificate includes calibration and uncertainty data from the calibration laboratory. The calibration laboratory's Scope of Accreditation can be found on Beamex's website ([www.beamex.com](http://www.beamex.com)). The MC6-Ex has specifications for 1-year total uncertainty.

### 1 Year Uncertainty figures:

- Pressure uncertainty starting from  $\pm(0.01 \% \text{ FS} + 0.025 \% \text{ of reading})$ .
- Temperature – RTD temperature measurement uncertainty starting from  $\pm 0.015 \text{ }^\circ\text{C}$ .
- Electrical – current measurement uncertainty starting from  $\pm(1 \mu\text{A} + 0.01 \% \text{ of reading})$ .

## Safe calibration in extreme environments

The MC6-Ex is an intrinsically safe, ATEX, IECEx and North American certified Ex ia IIC T4 Ga – classified advanced multifunction field calibrator. It is designed for use in extreme environments, such as offshore platforms, oil refineries, chemical and petrochemical plants where inflammable gases may be present. The robust IP65-rated dust- and water-proof casing, along with integrated impact protectors, makes the MC6-Ex an ideal calibrator for use in wet and dusty environments subject to wide temperature variations.

## Multi-bus field communicator for HART, FOUNDATION Fieldbus and Profibus PA instruments

The **communicator** mode is a multi-bus communicator for HART, FOUNDATION Fieldbus and Profibus PA instruments. All of the communicator electronics for all protocols are built into the MC6-Ex, including internal loop power supply with various required impedances for different buses, which means there is no need to use any external loop supply or resistors.

The MC6-Ex **multi-bus communicator** can be used with all types of fieldbus instruments, not only pressure and temperature transmitters. All 3 protocols can be simultaneously installed into an MC6-Ex, and therefore the very same device can be used as a HART, FOUNDATION Fieldbus and Profibus PA communicator. With the MC6-Ex, all parameters in all blocks of a fieldbus instrument can be accessed. Its' memory stores device descriptions for the fieldbus instruments. When new instruments are introduced on the market, new device description files will be made available and can be easily downloaded into the memory.

## Communication with calibration software

Using the MC6-Ex together with calibration management software provides a complete documenting calibration system that produces calibration certificates automatically. The benefits of the system include automated calibration procedures and

paperless calibration management. The MC6-Ex can also be part of the paperless integration to the customer's own ERP system.

## User-friendly interface

The MC6-Ex has a large 5.7" color touch-screen with high resolution and an effective adjustable backlight. In addition, the MC6-Ex has a membrane keypad. A soft number keypad and alphabetical QWERTY text keypad will appear whenever necessary for easy number/text entries. The smart battery pack is field replaceable NiMH and it can be charged either inside or outside the calibrator.

## Modularity means versatility

The MC6-Ex is an extremely versatile calibrator with many different functions. The modular construction of the MC6-Ex provides flexibility for the user. It is one device with five different operational modes, which means that it is fast and easy to use, and you can carry less equipment in the field. The operation modes are: meter, calibrator, documenting calibrator, data logger and fieldbus communicator.

## Automated temperature and pressure calibrations

The MC6-Ex can communicate with selected pressure controllers and temperature dry-blocks to automate calibrations. MC6-Ex can send setpoints to controllers and read the output from the device under test automatically. Controllers can be used only in safe area.

# Additional features

FEATURE	SPECIFICATION
Scaling	A versatile programmable scaling function allows user to scale any measurement or generation unit into any other unit. Supports also rooting transfer function for flow applications. Also, custom units and custom transfer functions are supported.
Alarm	An alarm that can be programmed with high or low limit, as well as slow rate or fast rate limit.
Leak test	A dedicated function that can be used to analyse a change in any measurement. Can be used for pressure leak testing as well as any stability testing.
Damping	A programmable damping allows user to filter any measurement.
Resolution	Possibility to change the resolution of any measurement by reducing or adding decimals.
Step	A programmable step function for any generation or simulation.
Ramp	A programmable ramp function for any generation or simulation.
Quick access	Possibility to set five (5) quick access buttons in generation to easily generate the programmed values.
Spinner	Possibility to easily step any digit in the generation value up or down.
Additional info	Allow user to see additional information in the screen such as: min, max, rate, average, internal temperature, RTD sensor's resistance, thermocouple's thermovoltage, range min/max, etc.
Function info	Displays more information on the selected function.
Connection diagrams	Displays a picture showing where to connect the test leads with the selected function.
Calibration references	Allows you to document the additional references that were used during the calibration and passes on the information to Beamex CMX calibration software.
Users	Possibility to create a list of persons in the documenting calibrator in order to easily select who did the calibration.
Custom pressure unit	Large number of custom pressure units can be created.
Custom RTD sensor	Unlimited number of custom RTD sensors can be created using the Callendar van Dusen coefficients.
Custom point sets	Unlimited number of custom point sets can be created in calibration of an instrument, or step generation.
Custom transfer function	Unlimited number of custom transfer functions can be created in calibration of an instrument or in scaling function.

Note: All functions are not available in all user interface modes.



# Specifications

## GENERAL SPECIFICATIONS

GENERAL			
Display	5.7" Diagonal 640 x 480 TFT LCD Module		
Touch Panel	5-wire resistive touch screen		
Keyboard	Membrane keyboard		
Backlight	LED backlight, adjustable brightness		
Weight	2.5...2.9 kg (5.5...6.4 lb)		
Dimensions	207 mm x 231 mm x 80 mm (D x W x H)		
Battery Pack type	Rechargeable NiMh, 4200 mAh, 9.6 V		
Charging time	10 hours from 0 to 100% at 0...30 °C (32...86 °F)		
Charger supply	100...240 VAC, 50–60 Hz		
Battery operation	4...8 h (Heavy / Normal usage)		
Operating temperature	–10...50 °C		
Operating temperature while charging batteries	0...40 °C		
Storage temperature	–20...60 °C		
Specifications valid	–10...50 °C, unless other mentioned		
Humidity	0 to 80% R.H. non condensing		
Warmup time	Specifications valid after a 5 minute warmup period		
Max. input voltage	30 V AC, 30 V DC		
Ex Safety	ATEX directive 2014/34/EU		
Ex marking	⊕ II 1 G	Ex ia IIC T4 Ga	Ta = –10 °C...+50 °C
Ex marking (North America):	Class I, Zone 0, AEx ia IIC T4 GA Class I, Division 1, Groups A-D, T4 Tamb –10 °C to +50 °C, Intrinsically Safe, Sécurité intrinsèque		
ATEX Certification	EN 60079-0:2012/A11:2013	EN 60079-11:2012	Certificate No. EESF 18 ATEX 071X
IEC Certification	IEC 60079-0:2017, Edition:7.0	IEC 60079-11:2011, Edition:6.0	Certificate No. IECEx EESF 18.0033X
North American Certification (SGS):	UL 913, 8th Ed. Rev. October 16, 2015 UL 60079-0 6th Ed. Rev. July 26, 2013 CAN/CSA C22.2 No. 60079-0:15 Rev. October 2015 UL 60079-11, 6th Ed. 02/15/2013 CAN/CSA C22.2 No. 60079-11:14 Certificate No SGSNA/18/SUW00222		
RoHS Compliance	RoHS II Directive 2011/65/EU, EN 50581:2012		
Safety	Directive 2014/30/EU, EN 61010-1:2010, EN 61010-2-030:2010		
EMC	Directive 2014/30/EU, EN 61326-1:2013, EN 61000-3-2:2014, EN 61000-3-3:2013		
Ingress protection	IP 65, IEC/EN 60529		
Drop test	1 meter drop test		
Max Altitude	3000 m (9842 ft)		
Display update rate	3 / second		
Warranty	Warranty 3 years. 1 year for battery pack. Additional warranty extension programs available.		

## MEASUREMENT, GENERATION AND SIMULATION FUNCTIONS

- Pressure measurement (internal/external pressure modules)
  - Voltage measurement (±500 mV and ±30 VDC)
  - Current measurement (±100 mA) (internal or external supply)
  - Frequency measurement (0...50 kHz)
  - Pulse counting (0...10 Mpulse)
  - Switch state sensing (dry/wet switch)
  - Built-in loop supply
  - Voltage generation (±500 mV and –1.5...10.5 VDC)
  - Current generation (0...25 mA) (active/passive, i.e. Internal or external supply)
  - Resistance measurement, two simultaneous channels (0...4 kΩ)
  - Resistance simulation (0...4 kΩ)
  - RTD measurement, two simultaneous channels
  - RTD simulation
  - TC measurement, two simultaneous channels (universal connector/mini-plug)
  - TC simulation
  - Frequency generation (0...3 kHz)
  - Pulse queue generation (0...10 Mpulse)
  - HART communicator
  - FOUNDATION Fieldbus communicator
  - Profibus PA communicator
- (Some of the above functions are optional)

# PRESSURE MEASUREMENT

INTERNAL MODULES	EXTERNAL MODULES	UNIT	RANGE <sup>(2)</sup>	RESOLUTION	1 YEAR UNCERTAINTY (±) <sup>(1)</sup>
PB-Ex	EXT B-IS	kPa a mbar a psi a	70 to 120 700 to 1200 10.15 to 17.4	0.01 0.1 0.001	0.05 kPa 0.5 mbar 0.0073 psi
P10mD-Ex	EXT10mD-IS	kPa diff mbar diff iwc diff	±1 ±10 ±4	0.0001 0.001 0.001	0.05% Span + 0.1% RDG
P100m-Ex	EXT100m-IS	kPa mbar iwc	0 to 10 0 to 100 0 to 40	0.0001 0.001 0.001	0.025% FS + 0.025% RDG
P400mC-Ex	EXT400mC-IS	kPa mbar iwc	±40 ±400 ±160	0.001 0.01 0.001	0.02% FS + 0.025% RDG
P1C-Ex	EXT1C-IS	kPa bar psi	±100 ±1 -14.5 to 15	0.001 0.00001 0.0001	0.015% FS + 0.025% RDG
P2C-Ex	EXT2C-IS	kPa bar psi	-100 to 200 -1 to 2 -14.5 to 30	0.001 0.00001 0.0001	0.01% FS + 0.025% RDG
P6C-Ex	EXT6C-IS	kPa bar psi	-100 to 600 -1 to 6 -14.5 to 90	0.01 0.0001 0.001	0.01% FS + 0.025% RDG
P20C-Ex	EXT20C-IS	kPa bar psi	-100 to 2000 -1 to 20 -14.5 to 300	0.01 0.0001 0.001	0.01% FS + 0.025% RDG
P60-Ex	EXT60-IS	kPa bar psi	0 to 6000 0 to 60 0 to 900	0.1 0.001 0.01	0.01% FS + 0.025% RDG
P100-Ex	EXT100-IS	MPa bar psi	0 to 10 0 to 100 0 to 1500	0.0001 0.001 0.01	0.01% FS + 0.025% RDG
P160-Ex	EXT160-IS	MPa bar psi	0 to 16 0 to 160 0 to 2400	0.0001 0.001 0.01	0.01% FS + 0.025% RDG
–	EXT250-IS	MPa bar psi	0 to 25 0 to 250 0 to 3700	0.001 0.01 0.1	0.015% FS + 0.025% RDG
–	EXT600-IS	MPa bar psi	0 to 60 0 to 600 0 to 9000	0.001 0.01 0.1	0.015% FS + 0.025% RDG
–	EXT1000-IS	MPa bar psi	0 to 100 0 to 1000 0 to 15000	0.001 0.01 0.1	0.015% FS + 0.025% RDG

<sup>1)</sup> Uncertainty includes reference standard uncertainty, hysteresis, nonlinearity, repeatability and typical long term stability for mentioned period (k=2).

<sup>2)</sup> Every internal/external gauge pressure module's range may be displayed also in absolute pressure if the barometric module (PB or EXT B) is installed/connected.

Maximum number of internal pressure modules is 2 gauge/differential pressure modules and one barometric (PB) module. There is a connection for external pressure modules.

## SUPPORTED PRESSURE UNITS

Pa, kPa, hPa, MPa, mbar, bar, gf/cm<sup>2</sup>, kgf/cm<sup>2</sup>, kgf/m<sup>2</sup>, kp/cm<sup>2</sup>, lbf/ft<sup>2</sup>, psi, at, torr, atm, ozf/in<sup>2</sup>, iwc, inH<sub>2</sub>O, ftH<sub>2</sub>O, mmH<sub>2</sub>O, cmH<sub>2</sub>O, mH<sub>2</sub>O, mmHg, cmHg, mHg, inHg, mmHg(0 °C), inHg(0 °C), mmH<sub>2</sub>O(60°F), mmH<sub>2</sub>O(68°F), mmH<sub>2</sub>O(4 °C), cmH<sub>2</sub>O(60°F), cmH<sub>2</sub>O(68°F), cmH<sub>2</sub>O(4 °C), inH<sub>2</sub>O(60°F), inH<sub>2</sub>O(68°F), inH<sub>2</sub>O(4 °C), ftH<sub>2</sub>O(60°F), ftH<sub>2</sub>O(68°F), ftH<sub>2</sub>O(4 °C). Large number of user pressure units can be created.

## TEMPERATURE COEFFICIENT

<±0.001% RDG/ °C outside 15–35 °C (59–95 °F).  
P10mD / EXT10mD: < ±0.002% Span/ °C outside 15–35 °C (59–95 °F)

## MAX OVERPRESSURE

2 times the nominal pressure. Except following modules;  
PB/EXTB: 1200 mbar abs (35.4 inHg abs). P10mD/EXT10mD: 200 mbar (80 iwc).  
EXT600: 900 bar (13000 psi). EXT1000: 1000 bar (15000 Psi).

## PRESSURE MEDIA

Modules up to P6C/EXT6C: dry clean air or other clean, inert, non-toxic, non-corrosive gases. Modules P20C/EXT20C and higher: clean, inert, non-toxic, non-corrosive gases or liquids.

## WETTED PARTS

AISI316 stainless steel, Hastelloy, Nitrile rubber

## PRESSURE CONNECTION

PB/EXTB: M5 (10/32") female.  
P10mD/EXT10mD: Two M5 (10/32") female threads with hose nipples included.  
P100m/EXT100m to P20C/EXT20C: G1/8" (ISO228/1) female. A conical 1/8" BSP male with 60° internal cone adapter included for Beamex hose set.  
P60, P100, P160: G1/8" (ISO228/1) female.  
EXT60 to EXT1000: G ¼" (ISO228/1) male.

# TC MEASUREMENT & SIMULATION

## TC1 measurement & simulation / TC2 measurement

TYPE	RANGE (°C)	RANGE (°C)	1 YEAR UNCERTAINTY (±) <sup>(1)</sup>
B <sup>(2)</sup>	0...1820	0...200	<sup>(3)</sup>
		200...500	2.0 °C
		500...800	0.8 °C
		800...1820	0.5 °C
R <sup>(2)</sup>	-50...1768	-50...0	1.0 °C
		0...150	0.7 °C
		150...400	0.45 °C
		400...1768	0.4 °C
S <sup>(2)</sup>	-50...1768	-50...0	0.9 °C
		0...100	0.7 °C
		100...300	0.55 °C
		300...1768	0.45 °C
E <sup>(2)</sup>	-270...1000	-270...-200	<sup>(3)</sup>
		-200...0	0.07 °C + 0.06% RDG
		0...1000	0.07 °C + 0.005% RDG
J <sup>(2)</sup>	-210...1200	-210...-200	<sup>(3)</sup>
		-200...0	0.08 °C + 0.06% RDG
		0...1200	0.08 °C + 0.006% RDG
K <sup>(2)</sup>	-270...1372	-270...-200	<sup>(3)</sup>
		-200...0	0.1 °C + 0.1% RDG
		0...1000	0.1 °C + 0.007% RDG
		1000...1372	0.017% RDG
N <sup>(2)</sup>	-270...1300	-270...-200	<sup>(3)</sup>
		-200...-100	0.2% RDG
		-100...0	0.15 °C + 0.05% RDG
		0...800	0.15 °C
T <sup>(2)</sup>	-270...400	800...1300	0.07 °C + 0.01% RDG
		-270...-200	<sup>(3)</sup>
		-200...0	0.1 °C + 0.1% RDG
U <sup>(4)</sup>	-200...600	0...400	0.1 °C
		-200...0	0.1 °C + 0.07% RDG
L <sup>(4)</sup>	-200...900	0...600	0.1 °C
		-200...0	0.08 °C + 0.04% RDG
C <sup>(5)</sup>	0...2315	0...900	0.08 °C + 0.005% RDG
		1000...2315	0.3 °C
G <sup>(6)</sup>	0...2315	0...60	0.027% RDG
		60...200	<sup>(3)</sup>
		200...400	1.0 °C
		400...1500	0.5 °C
		1500...2315	0.3 °C
D <sup>(5)</sup>	0...2315	0...140	0.02% RDG
		140...1200	0.4 °C
		1200...2100	0.3 °C
		2100...2315	0.024% RDG
			0.65 °C

Resolution 0.01 °C.

With internal reference junction please see separate specification.

Also other thermocouple types available as option, please contact Beamex.

<sup>(1)</sup> Uncertainty includes reference standard uncertainty, hysteresis, nonlinearity, repeatability and typical long term stability for mentioned period (k=2).

<sup>(2)</sup> IEC 60584, NIST MN 175, BS 4937, ANSI MC96.1

<sup>(3)</sup> ±0.007% of thermovoltage + 4 µV

<sup>(4)</sup> DIN 43710

<sup>(5)</sup> ASTM E 988 - 96

<sup>(6)</sup> ASTM E 1751 - 95e1

<b>Measurement input impedance</b>	> 10 MΩ
<b>Simulation maximum load current</b>	1 mA
<b>Simulation load effect</b>	< 5 µV/mA
<b>Supported units</b>	°C, °F, Kelvin, °Ré, °Ra
<b>Connector</b>	TC1: Universal TC connector , TC2: TC Miniplug

# RTD MEASUREMENT & SIMULATION

## R1 & R2 measurement

SENSOR TYPE	RANGE (°C)	RANGE (°C)	1 YEAR UNCERTAINTY (±) <sup>(1)</sup>
Pt50(385)	-200...850	-200...270 270...850	0.03 °C 0.012% RDG
Pt100(375) Pt100(385) Pt100(389) Pt100(391) Pt100(3926)	-200...850	-200...0 0...850	0.015 °C 0.015 °C + 0.012% RDG
Pt100(3923)	-200...600	-200...0 0...600	0.015 °C 0.015 °C + 0.012% RDG
Pt200(385)	-200...850	-200...-80 -80...0 0...260 260...850	0.01 °C 0.02 °C 0.02 °C + 0.012% RDG 0.045 °C + 0.02% RDG
Pt400(385)	-200...850	-200...-100 -100...0 0...850	0.01 °C 0.02 °C 0.045 °C + 0.019% RDG
Pt500(385)	-200...850	-200...-120 -120...-50 -50...0 0...850	0.01 °C 0.02 °C 0.045 °C 0.045 °C + 0.019% RDG
Pt1000(385)	-200...850	-200...-150 -150...-50 -50...0 0...850	0.008 °C 0.03 °C 0.04 °C 0.04 °C + 0.019% RDG
Ni100(618)	-60...180	-60...0 0...180	0.012 °C 0.012 °C + 0.006% RDG
Ni120(672)	-80...260	-80...0 0...260	0.012 °C 0.012 °C + 0.006% RDG
Cu10(427)	-200...260	-200...260	0.16 °C

72

## R1 Simulation

SENSOR TYPE	RANGE (°C)	RANGE (°C)	1 YEAR UNCERTAINTY (±) <sup>(1)</sup>
Pt50(385)	-200...850	-200...270 270...850	0.11 °C 0.11 °C + 0.015% RDG
Pt100(375) Pt100(385) Pt100(389) Pt100(391) Pt100(3926)	-200...850	-200...0 0...850	0.05 °C 0.05 °C + 0.014% RDG
Pt100(3923)	-200...600	-200...0 0...600	0.05 °C 0.05 °C + 0.014% RDG
Pt200(385)	-200...850	-200...-80 -80...0 0...260 260...850	0.025 °C 0.035 °C 0.04 °C + 0.011% RDG 0.06 °C + 0.02% RDG
Pt400(385)	-200...850	-200...-100 -100...0 0...850	0.015 °C 0.03 °C 0.05 °C + 0.019% RDG
Pt500(385)	-200...850	-200...-120 -120...-50 -50...0 0...850	0.015 °C 0.025 °C 0.05 °C 0.05 °C + 0.019% RDG
Pt1000(385)	-200...850	-200...-150 -150...-50 -50...0 0...850	0.011 °C 0.03 °C 0.043 °C 0.043 °C + 0.019% RDG
Ni100(618)	-60...180	-60...0 0...180	0.042 °C 0.037 °C + 0.001% RDG
Ni120(672)	-80...260	-80...0 0...260	0.042 °C 0.037 °C + 0.001% RDG
Cu10(427)	-200...260	-200...260	0.52 °C

For platinum sensors Callendar van Dusen and ITS-90 coefficients can be programmed. Also other RTD types available as option, please contact Beamex.

<sup>1)</sup> Uncertainty includes reference standard uncertainty, hysteresis, nonlinearity, repeatability and typical long term stability for mentioned period. (k=2)



FEATURE	SPECIFICATION
RTD Measurement current	Pulsed, bi-directional 0.2 mA
4-wire connection	Measurement specifications valid
3-wire measurement	Add 13.5 mΩ
Max resistance excitation current	2 mA (0...200 Ω), 1 mA (200...400 Ω), 0.5 mA (400...2000 Ω), 0.25 mA (2000...4000 Ω). $I_{exc} \times R_{sim} < 1.0 V$
Min resistance excitation current	$\geq 0.1 mA$
Simulation settling time with pulsed excitation current	$< 2 ms$
Supported units	°C, °F, Kelvin, °Ré, °Ra

## INTERNAL REFERENCE JUNCTION

### TC1 & TC2

RANGE	1 YEAR UNCERTAINTY ( $\pm$ ) <sup>(1)</sup>
-10...50 °C	$\pm 0.15$ °C

Specifications valid in temperature range; 15...35 °C.

Temperature coefficient outside of 15...35 °C;  $\pm 0.005$  °C/°C.

Specifications assumes that calibrator has stabilized in environmental condition, being switched on, for minimum of 90 minutes. For a measurement or simulation done sooner than that, please add uncertainty of 0.15 °C.

In order to calculate the total uncertainty of thermocouple measurement or simulation with internal reference junction used, please add the relevant thermocouple uncertainty and the Internal Reference Junction uncertainty together as a root sum of the squares.

<sup>(1)</sup> Uncertainty includes reference standard uncertainty, hysteresis, nonlinearity, repeatability and typical long term stability for mentioned period. ( $k=2$ )



## VOLTAGE MEASUREMENT

### IN (-30...30 V)

RANGE	RESOLUTION	1 YEAR UNCERTAINTY ( $\pm$ ) <sup>1)</sup>
-30.3 V...-5 V	0.0001 V	0.25 mV + 0.006% RDG
-5 V...-500 mV	0.00001 V	0.25 mV + 0.006% RDG
-500 mV...+500 mV	0.000001 V	5 $\mu$ V + 0.006% RDG
+500 mV...+5 V	0.00001 V	0.25 mV + 0.006% RDG
+5 V...+30.3 V	0.0001 V	0.25 mV + 0.006% RDG

FEATURE	SPECIFICATION
Input impedance	> 1 M $\Omega$
Supported units	V, mV, $\mu$ V

## CURRENT MEASUREMENT

### IN (-100...100 mA)

RANGE	RESOLUTION	1 YEAR UNCERTAINTY ( $\pm$ ) <sup>1)</sup>
-101...-25 mA	0.001 mA	1 $\mu$ A + 0.01% RDG
-25...25 mA	0.0001 mA	1 $\mu$ A + 0.01% RDG
+25...+101 mA	0.001 mA	1 $\mu$ A + 0.01% RDG

FEATURE	SPECIFICATION
Input impedance	< 10 $\Omega$
Supported units	mA, $\mu$ A

## INTERNAL LOOP SUPPLY

FEATURE	SPECIFICATION
Internal Loop supply	19 V $\pm$ 10% (12 V@max 50 mA)
Internal Loop supply (fieldbus module installed)	19 V $\pm$ 10% (12 V@max 25 mA)
Output impedance	130 $\Omega$
Output impedance in HART compatible mode	260 $\Omega$
Output impedance in FF/PA compatible mode	130 $\Omega$

## FREQUENCY MEASUREMENT

### IN (0.0027...50 000 Hz)

RANGE	RESOLUTION	1 YEAR UNCERTAINTY ( $\pm$ ) <sup>1)</sup>
0.0027...0.5 Hz	0.000001 Hz	0.000002 Hz + 0.002% RDG
0.5...5 Hz	0.00001 Hz	0.00002 Hz + 0.002% RDG
5...50 Hz	0.0001 Hz	0.0002 Hz + 0.002% RDG
50...500 Hz	0.001 Hz	0.002 Hz + 0.002% RDG
500...5000 Hz	0.01 Hz	0.02 Hz + 0.002% RDG
5000...51000 Hz	0.1 Hz	0.2 Hz + 0.002% RDG

FEATURE	SPECIFICATION
Input impedance	115 k $\Omega$
Trigger level	Dry contact 1 V, wet contact -1...14 V
Minimum signal amplitude	1.0 V <sub>pp</sub> (<10 kHz), 1.2 V <sub>pp</sub> (10...50 kHz)
Supported units	Hz, kHz, cph, cpm, 1/Hz(s), 1/kHz(ms), 1/MHz( $\mu$ s)

1) Uncertainty includes reference standard uncertainty, hysteresis, non-linearity, repeatability and typical long-term stability for the mentioned period (k=2).

## SWITCH SENSING

FEATURE	SPECIFICATION
Test Voltage, Dry contact (Trigger level)	2.3 V, 0.1 mA (1 V)
Trigger level, Wet contact	-1 ... 14 V
Input impedance	115 kΩ

## VOLTAGE MEASUREMENT

### TC1 & TC2 (-500 mV ... +500 mV)

RANGE	RESOLUTION	1 YEAR UNCERTAINTY (±) <sup>1)</sup>
-510 ... +510 mV	0.001 mV	4 μV + 0.007% RDG

FEATURE	SPECIFICATION
Input impedance	> 10 MΩ
Supported units	V, mV, μV
Connector	TC1: Universal TC connector, TC2: TC Miniplug

## VOLTAGE GENERATION

### TC1 (-500 mV ... +500 mV)

RANGE	RESOLUTION	1 YEAR UNCERTAINTY (±) <sup>1)</sup>
-500 ... +500 mV	0.001 mV	4 μV + 0.007% RDG

FEATURE	SPECIFICATION
Maximum load current	1 mA
Load effect	< 5 μV/mA
Supported units	V, mV, μV

## VOLTAGE GENERATION

### OUT (-1.5 ... 10.5 V)

RANGE	RESOLUTION	1 YEAR UNCERTAINTY (±) <sup>1)</sup>
-1.5 ... 10.5 V	0.00001 V	0.1 mV + 0.007% RDG

FEATURE	SPECIFICATION
Maximum load current	1 mA
Short circuit current	> 40 mA
Load effect	< 20 μV/mA
Supported units	V, mV, μV

<sup>1)</sup> Uncertainty includes reference standard uncertainty, hysteresis, non-linearity, repeatability and typical long-term stability for the mentioned period (k=2).

## CURRENT GENERATION

### OUT (0...25 mA)

RANGE	RESOLUTION	1 YEAR UNCERTAINTY ( $\pm$ ) <sup>(1)</sup>
0...25 mA	0.0001 mA	1 $\mu$ A + 0.01% RDG

FEATURE	SPECIFICATION
Internal loop supply	9.0 V a 1 mA, 6.0 V a 20 mA
Max load impedance (source)	300 $\Omega$ @ 20 mA
Max external loop supply	30 VDC
Supported units	mA, $\mu$ A

## FREQUENCY GENERATION

### OUT (0.0005...3000 Hz)

RANGE	RESOLUTION	1 YEAR UNCERTAINTY ( $\pm$ ) <sup>(1)</sup>
0.0005...0.5 Hz	0.000001 Hz	0.000002 Hz + 0.002% RDG
0.5...5 Hz	0.00001 Hz	0.00002 Hz + 0.002% RDG
5...50 Hz	0.0001 Hz	0.0002 Hz + 0.002% RDG
50...500 Hz	0.001 Hz	0.002 Hz + 0.002% RDG
500...3000 Hz	0.01 Hz	0.02 Hz + 0.002% RDG

FEATURE	SPECIFICATION
Maximum load current	1 mA
Wave forms	Positive square, symmetric square
Output amplitude positive square wave	0...10.5 Vpp
Output amplitude symmetric square wave	0...4 Vpp
Amplitude accuracy	< 15% of amplitude
Duty Cycle	3000 Hz (40...60%), 100 Hz (10...90%), 10 Hz (1...99%)
Supported units	Hz, kHz, cph, cpm, 1/Hz(s), 1/kHz(ms), 1/MHz( $\mu$ s)

76

## RESISTANCE MEASUREMENT

### R1 & R2 (0...4000 $\Omega$ )

RANGE	RESOLUTION	1 YEAR UNCERTAINTY ( $\pm$ ) <sup>(1)</sup>
-1...100 $\Omega$	0.001 $\Omega$	6 m $\Omega$
100...110 $\Omega$	0.001 $\Omega$	0.006% RDG
110...150 $\Omega$	0.001 $\Omega$	0.007% RDG
150...300 $\Omega$	0.001 $\Omega$	0.008% RDG
300...400 $\Omega$	0.001 $\Omega$	0.009% RDG
400...4040 $\Omega$	0.01 $\Omega$	12 m $\Omega$ + 0.015% RDG

FEATURE	SPECIFICATION
Measurement current	Pulsed, bi-directional, 0.2 mA
4-wire connection	Measurement specifications valid
3-wire measurement	Add 13.5 m $\Omega$
Supported units	$\Omega$ , k $\Omega$

<sup>1)</sup> Uncertainty includes reference standard uncertainty, hysteresis, non-linearity, repeatability and typical long-term stability for the mentioned period (k=2).



## RESISTANCE SIMULATION

### R1 (0...4000 Ω)

RANGE	RESOLUTION	1 YEAR UNCERTAINTY (±) <sup>1)</sup>
0...100 Ω	0.001 Ω	20 mΩ
100...400 Ω	0.001 Ω	10 mΩ + 0.01% RDG
400...4000 Ω	0.01 Ω	20 mΩ + 0.015% RDG

FEATURE	SPECIFICATION
Max resistance excitation current	2 mA (0...200 Ω), 1 mA (200...400 Ω), 0.5 mA (400...2000 Ω), 0.25 mA (2000...4000 Ω). $I_{exc} \times R_{sim} < 1.0 \text{ V}$
Min resistance excitation current	≥ 0.1 mA
Settling time with pulsed excitation current	< 2 ms
Supported units	Ω, kΩ

1) Uncertainty includes reference standard uncertainty, hysteresis, non-linearity, repeatability and typical long-term stability for the mentioned period (k=2).

## STANDARD ACCESSORIES

- Accredited calibration certificate
- User guide
- Safety Information leaflet
- Computer cable
- Battery charger / eliminator
- Internal NiMH battery pack
- Test leads and clips

## OPTIONAL ACCESSORIES

- Soft carrying case
- Spare battery pack

# Beamex MC6-Ex

## INTRINSICALLY SAFE ADVANCED FIELD CALIBRATOR AND COMMUNICATOR

⚠ See user manual for input and output parameters

78

The Beamex MC6-Ex is ATE, IECEx and North American certified and designed for use in potentially explosive environments, such as offshore platforms, oil refineries, chemical and petrochemical plants where inflammable gases may be present. Beamex MC6-Ex is an advanced, high-accuracy field calibrator and communicator. It offers calibration capabilities for pressure, temperature and various electrical signals. The MC6-Ex also contains a fieldbus communicator for HART, FOUNDATION Fieldbus and Profibus PA instruments. The MC6-Ex is one device with five different operational modes, which means that it is fast and easy to use, less equipment needs to be carried in the field. The operation modes are: meter, calibrator, documenting calibrator, data logger and fieldbus communicator. In addition, the MC6-Ex communicates with Beamex calibration management software, enabling fully automated and paperless calibration and documentation.



### Guided procedures

The MC6-Ex provides automated, guided procedures. For instance, whenever a certain measurement or generation is selected, the user interface shows where to make the connections.

### Safe and accurate Ex-field calibrator

The ATE, IECEx and North American certified, IP65-rated MC6-Ex with impact protectors and membrane keyboard is robust and the most accurate Ex-calibrator on the market.

### Paperless calibration

The MC6-Ex communicates with calibration software enabling fully automated and paperless calibration and documentation.

### Communicator

Smart instrumentation is becoming more and more common in today's process plants. The most widely used smart instrument protocols are HART, FOUNDATION Fieldbus and Profibus PA. Therefore, in addition to a calibrator, an engineer often needs to use a field communicator. The MC6-Ex combines these two; it's a calibrator and a communicator.

### Main features

- ▶ Highly accurate all-in-one calibrator
- ▶ The Beamex MC6-Ex is ATE, IECEx and North American certified and designed for use in potentially explosive environments
- ▶ Multi-bus communicator for HART, FOUNDATION Fieldbus and Profibus PA instruments
- ▶ Documenting calibration capabilities for pressure, temperature, electrical and frequency signals
- ▶ Five operational modes: meter, calibrator, documenting calibrator, data logger and communicator
- ▶ Automates calibration procedures for paperless calibration management



# Beamex MC6-T

MULTIFUNCTION TEMPERATURE CALIBRATOR  
AND COMMUNICATOR

79877348759834759833  
87984654546546  
7987465465465132132131  
65456789012345678901  
6553678975684653400



Versatile temperature calibration







# Versatile temperature calibration

The Beamex MC6-T is an extremely versatile portable automated temperature calibration system. It combines a state-of-the-art temperature dry-block with Beamex MC6 multifunction process calibrator technology. It offers versatility, that no other temperature calibrator can match.

With the ability to generate temperature as well as measure and simulate temperature and electrical signals, it offers a really unique combination of functionality. In addition to temperature calibration abilities, the MC6-T also offers electrical and pressure calibration capability, all in one device.

The MC6-T provides superior metrological performance and accuracy for temperature calibrations, while being robust, light and easy to carry field calibrator.

The calibrator is designed for industrial environments and it is designed to minimize the impact of varying environmental conditions and AC power fluctuations.

A large multilingual color touch screen, combined with numerical and graphical views, provides an easy to use system available in multiple languages.

The MC6-T has a built-in field communicator for HART, FOUNDATION Fieldbus H1 and Profibus PA instruments. This enables calibration, configuration and trimming of modern smart instruments with a single device, without the need to carry a separate field communicator.

MC6-T is a documenting calibrator that communicates with calibration management software to enable a fully digitalized, paperless calibration process and documentation database. Thanks to the internal rechargeable battery, the process calibrator functionality in the MC6-T can be used also without mains voltage. The mains voltage is needed only for heating and cooling.

MC6-T includes several unique safety features, such as a tilt sensor, warning light and stand-alone overheating protection.



## MC6-T comes in two versions:

With all its functionality, the MC6-T can be considered a mobile calibration laboratory, replacing a large number of conventional separate single-function calibration equipment, making it easy to carry it with you out in the field.

### MC6-T150

Generate temperatures between -30 ... 150 °C (-22 ... 302 °F)



### MC6-T660

Generate temperatures between 50 ... 660 °C (122 ... 1220 °F)





beames MC6-T



Navigation buttons: Home, Back, Forward, Stop, and Refresh.

Please see user manual for safe use of the equipment.  
All terminals, max input: 60 VDC, 30 VAC, 100mA.

Terminal block labels: RTD, TC, RTD, TC, V, mA, Hz, mA Feedback, IN, OUT, 100%.

MC6-T150  
-30 ... 150 °C

115 / 230 VAC, 50...60 Hz  
MAX 380 W  
FUSES: 230 V: T 3.15 A 250 V  
115 V: T 3.15 A 250 V

MAINS SWITCH  
ON / OFF

# Automatic documenting calibrator – digitalize your calibration process

## Superior metrological specifications and performance

MC6-T660 features an active triple zone temperature control technology for superior temperature gradient. MC6-T150 features a dual zone heating and cooling for optimum temperature control. The multizone temperature control technology ensures an excellent temperature gradient and compensates for the heat loss caused by the temperature sensors installed in the insert.

MC6-T offers excellent accuracy and stability. The unique temperature control algorithm provides fast heating and cooling without overshoots, improving efficiency and saving time. The adjustable control speed let you optimize for the speed and accuracy.

An accredited calibration certificate is included as standard as evidence of the accuracy.

## Made for industrial use

MC6-T is designed for demanding industrial environments. It is designed to minimize the effects of varying environmental conditions, typical in process industry field conditions.

It is also designed to minimize the effects of any mains voltage fluctuations, and it remains very stable in spite of changes in AC mains power voltage.

As MC6-T is a portable, small, lightweight and robust device, ideal for industrial field usage. Being a multifunctional device, it replaces several traditional single-function devices. It is easier to carry just one device with you.

With the optional carrying case, you can take the MC6-T and required accessories conveniently with you out to the field.

## Enhanced usability

MC6-T offers a large 5.7-inch backlit multilingual color touch screen user interface that can be easily used with bare fingers, gloved hands or any stylus. Direct numerical and QWERTY keyboards make it very easy and fast to enter data. There is no need to use clumsy arrow keys to enter a set point, just enter the temperature set point value. User interface can also be used with the membrane keys.

The user interface is divided into different operation modes for enhanced usability. The user interface offers numerical and graphical information.

## Extensive process calibrator functionality

MC6-T includes a built-in multifunctional process calibrator, based on the Beamex MC6 technology. The process calibrator can calibrate temperature, electrical and pressure signals.

It offers three simultaneous RTD / resistance and two thermocouple measurement channels. It can also simulate RTD and thermocouples signals, for calibrating temperature transmitters and other temperature instruments. It can also measure and generate various DC electrical signals.

So, in addition to calibrating temperature sensors and temperature loops, you can calibrate different kinds of process instruments.

MC6-T offers also a connection for Beamex external pressure modules (EXT) and can also be used for various pressure calibrations.

## Digital transformation of your calibration process

MC6-T is a documenting calibrator and communicates with calibration software. This enables a digitalized and fully paperless calibration process. Send an unlimited number of workorders from the calibration software, perform the calibration with MC6-T using automatic documentation, and finally send results back to the calibration software for viewing, analysis and storage.

You may also have the Beamex calibration software connected with your maintenance system, for a fully paperless flow of workorders and calibration data between the systems.

Using the MC6-T in conjunction with Beamex CMX calibration software, enables you to minimize any ALCOA related data integrity issues. MC6-T identifies users with their electronic signature and protects data against any tampering.



# USER INTERFACE MODES - ENHANCED USABILITY

## Temperature Calibrator

The Temperature Calibrator mode is optimized for easy and fast usage of the temperature generation and measurement. The desired temperature can be quickly entered using the virtual numerical keyboard. The internal or external reference probe can also be easily measured. The temperature values can be viewed in numerical or graphical view. Additional measurement or generation channels can also be measured simultaneously.



## Calibrator

The Calibrator mode is designed for calibrating various process instruments, such as transmitters or indicators. Transmitters typically have an input and an output. So, you either need to have two devices, or one device capable of doing two things simultaneously. The calibrator mode in MC6 is optimized for this type of use. The calibrator also offers different tools making the work easier.



## Data Logger

The Data Logger is designed for logging various measurement channels simultaneously. Often in industry, there is a need to measure signals for shorter or longer periods and to save the results in memory for later analysis. This may be related to trouble-shooting, surveillance or calibration. The data logger mode in MC6 is optimized for this type of use. It is also possible to generate or simulate signals during the data logging.





## Documenting Calibrator

The Documenting Calibrator mode is where you can automate your calibrations and make them fully paperless. Work orders from calibration software can be sent to Documenting Calibrator and the calibration results can be sent back to software. With paperless calibration, there is no need for manual error-prone pen and paper documenting, this improves the efficiency of calibration and improves the quality of results.



## Communicator

The Communicator mode is designed to communicate with smart field instruments. MC6-T supports HART, FOUNDATION Fieldbus or Profibus PA protocols. In today's process plants, smart instrumentation is being used to an increasing degree. Therefore, engineers need to use communicators or configuration software. With the field communicator built-in to the calibrator, there is no need to carry a separate communicator.

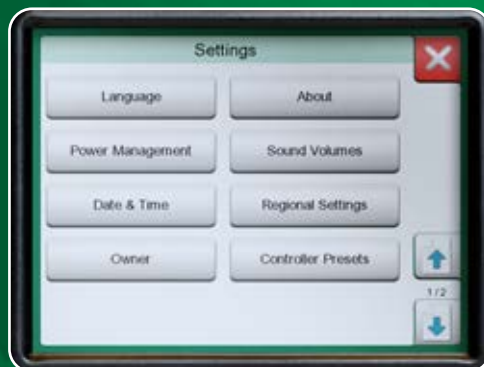

## Settings

The Settings mode allows you to edit the various settings of the calibrator. These settings include for example language selection, power management, regional settings, date & time and different maintenance settings.



# Truly multifunctional - carry less

## Built-in Field Communicator

MC6-T includes a field communicator for HART, FOUNDATION Fieldbus H1 and Profibus PA instruments. All protocols are modular, so you can choose the ones you need, and you can also add protocols later on as the requirements arise. With the help of the built-in communicator, you can configure and trim/adjust your smart instruments with a single MC6-T without the need to carry a separate field communicator with you. The communicator includes built-in loop supply and required impedances for the communications, so there is no need for separate power supply or impedances.

## Stability control adds confidence in temperature calibration

In temperature calibration, stability is a very important feature. Temperature changes slowly and the user must be sure that the readings are stable. MC6-T follows the stability and 2 sigma standard deviation of the temperature measurements and makes sure that only readings that are within the stability requirements are being used. This takes the guessing out of the picture and adds confidence in calibration, ensuring the best calibration uncertainty even for a novice user. The stability control is used for the reference sensor as well as the sensors to be calibrated.

## Advanced safety features

The MC6-T includes several advanced safety features. The unit has a red indicator light whenever the block is hot, as well as indication in the display. For safety reasons the MC6-T660 units has a tilt/orientation sensor. This will warn the user if the unit is tilted so much that calibration uncertainty is jeopardized. Also, it will switch off heating and turn on the fan if the unit is tilted too much, or if it falls on side. There is also processor independent stand-alone overheat protectors that will prevent overheating.

## Short and sanitary sensor calibration

In some industries, such as food and beverage and pharmaceutical, short and sanitary temperature sensors are used. These kinds of sensors, sometimes provided with a flange, are difficult to calibrate with traditional temperature dry-blocks. The MC6-T150 is designed so that it enables the calibration of short and flanged sanitary sensors. A dedicated insert used together with a special very short reference sensor with flexible cable. The cover of the block includes grooves for the reference sensor cable, allowing a sensor with a flange being accurately calibrated.

## External controllers

MC6-T supports communication with external temperature and pressure controllers. It can be used to automate temperature calibration with another (Beamex models or selected non-Beamex models) temperature block. For example, use it with your Beamex FB temperature dry block to extend the temperature range. Or use MC6-T to control your existing temperature block to automate the calibration process. Also, MC6-T can be used to automate pressure calibration by controlling an external pressure controller, such as Beamex POC8. This enables automatic calibration of various pressure instruments with MC6-T.

## Internal rechargeable battery

MC6-T includes an internal rechargeable battery pack. This unique feature allows you to use all other functions, except the temperature control, without mains voltage. For example, you can use the process calibrator functionality, field communicator, or communication with software, without the need to have mains power available.

## Carry less

Being a truly multifunctional device, the MC6-T can replace a large amount of conventional single-function devices. MC6-T includes a temperature dry block, temperature calibrator, electrical calibrator, pressure calibrator, multibus field communicator, loop supply, note pad, and many more. Using MC6-T allows you to carry less.

# Specifications

## GENERAL SPECIFICATIONS

FEATURE	VALUE
Dimensions	322 mm x 180 mm x 298 mm (12,68" x 7,09" x 11,73")
Weight	MC6-T150: 9.4 kg (20.7 lbs) MC6-T660: 8.6 kg (18.96 lbs)
Display	5.7" Diagonal 640 x 480 TFT LCD Module
Touch Panel	5-wire resistive touch screen
Keyboard	Membrane keyboard
Backlight	LED backlight, adjustable brightness
Power requirements	230 V $\pm$ 10%, 50/60 Hz, 380 W (MC6-T150), 1560 W (MC6-T660) 115 V $\pm$ 10%, 50/60 Hz, 380 W (MC6-T150), 1560 W (MC6-T660)
Fuse size (MC6-T660)	230 V: T 8A 250V / 115 V: T 16A 250V
Fuse size (MC6-T150)	230 V: T 3.15A 250V / 115 V: T 3.15A 250V
Max. input voltage	30 V AC, 60 V DC
Operating temperature	0 ... 45 °C (32 ... 113 °F)
Operating humidity	0 ... 90% R.H. non condensing
Storage temperature	-20 ... 60 °C (-4 ... 140 °F)
Computer interface	USB
Calibration certificate	Accredited calibration certificate
Warmup time	Specifications valid after a 5 minute warmup period
Battery type	Rechargeable lithium-ion polymer, 4300 mAh, 11.1 V
Charging time	Approximately 4 hours
Battery operation time	10 ... 16 hours
Battery operated functions	All functions except temperature control and R3 measurement
Safety	Directive 2014/35/EU, EN 61010-1:2010
EMC	Directive 2014/30/EU, EN 61326-1:2013
RoHS compliance	RoHS II Directive 2011/65/EU, EN 50581:2012
Drop	EN 61010-1:2013
Warranty	Warranty 3 years, 1 year for battery pack. Warranty extension programs available.

## MEASUREMENT, GENERATION AND SIMULATION FUNCTIONS

- Temperature generation
- Pressure measurement (internal barometric and external pressure modules)
- Voltage measurement ( $\pm$ 1 V and  $-1 \dots 60$  VDC)
- Current measurement ( $\pm$ 100 mA) (internal or external supply)
- Frequency measurement (0 ... 50 kHz)
- Pulse counting (0 ... 10 Mpulse)
- Switch state sensing (dry/wet switch)
- Built-in 24 VDC loop supply (low impedance, HART impedance or FF/PA impedance)
- Voltage generation ( $\pm$ 1 V and  $-3 \dots 24$  VDC)
- Current generation (0 ... 55 mA) (active/passive, i.e. Internal or external supply)
- Resistance measurement, three simultaneous channels (0 ... 4 k $\Omega$ )
- Resistance simulation (0 ... 4 k $\Omega$ )
- RTD measurement, three simultaneous channels
- RTD simulation
- TC measurement, two simultaneous channels (universal connector/mini-plug)
- TC simulation
- Frequency generation (0 ... 50 kHz)
- Pulse queue generation (0 ... 10 Mpulse)
- HART communicator
- FOUNDATION Fieldbus communicator
- Profibus PA communicator

(Some of the above functions are optional)



## TEMPERATURE SPECIFICATIONS

FEATURE	MC6-T150	MC6-T660
Temperature range at 23 °C (73 °F)	-30 ... 150 °C (-22 ... 302 °F)	50 ... 660 °C (122 ... 1220 °F)
Display uncertainty with internal reference <sup>1)</sup>	±0.15 °C	±0.2 °C at 50 °C ±0.3 °C at 420 °C ±0.5 °C at 660 °C
Stability <sup>2)</sup>	±0.01 °C	±0.02 °C at 50 °C ±0.03 °C at 420 °C ±0.04 °C at 660 °C
Axial uniformity at 40 mm	±0.05 °C	±0.05 °C at 50 °C ±0.25 °C at 420 °C ±0.40 °C at 660 °C
Axial uniformity at 60 mm	±0.07 °C	±0.10 °C at 50 °C ±0.40 °C at 420 °C ±0.60 °C at 660 °C
Radial uniformity Difference between borings	±0.01 °C	±0.01 °C at 50 °C ±0.05 °C at 420 °C ±0.08 °C at 660 °C
Loading effect with internal reference sensor With 4 pcs 6 mm sensors	± 0.08 °C	±0.02 °C at 50 °C ±0.08 °C at 420 °C ±0.15 °C at 660 °C
Loading effect with external 6 mm reference sensor With 3 pcs 6 mm sensors	±0.005 °C	±0.01 °C at 50 °C ±0.02 °C at 420 °C ±0.03 °C at 660 °C
Hysteresis	±0.03 °C	±0.15 °C
Display resolution	0.001 °C / °F / K	0.001 °C / °F / K
Immersion depth	150 mm (5.9 in)	150 mm (5.9 in)
Insert outer dimensions	30 mm (1.18 in)	24.5 mm (0.96 in)
Heating time	23 to 150 °C: 19 min -30 to 150 °C: 23 min	50 to 660 °C: 15 min
Cooling time	150 to 23 °C: 17 min 23 to -30 °C: 23 min 150 to -30 °C: 37 min	660 to 50 °C: 35 min 660 to 100 °C: 25 min
Stabilization time <sup>3)</sup>	5 to 10 min	10 min

1) Includes 1-year uncertainty in typical use

2) 30 minutes stability (2 sigma) after the device has reached the setpoint and has stabilized

3) Typical time to stability



# TC MEASUREMENT & SIMULATION

## TC1 measurement & simulation / TC2 measurement

TYPE	RANGE (°C)	RANGE (°C)	ACCURACY <sup>(1)</sup>	1 YEAR UNCERTAINTY (±) <sup>(2)</sup>
B <sup>(3)</sup>	0...1820	0...200	<sup>(8)</sup>	<sup>(4)</sup>
		200...500	1.5 °C	2.0 °C
		500...800	0.6 °C	0.8 °C
		800...1820	0.4 °C	0.5 °C
R <sup>(3)</sup>	-50...1768	-50...0	0.8 °C	1.0 °C
		0...150	0.6 °C	0.7 °C
		150...400	0.35 °C	0.45 °C
		400...1768	0.3 °C	0.4 °C
S <sup>(3)</sup>	-50...1768	-50...0	0.7 °C	0.9 °C
		0...100	0.6 °C	0.7 °C
		100...300	0.4 °C	0.55 °C
		300...1768	0.35 °C	0.45 °C
E <sup>(3)</sup>	-270...1000	-270...-200	<sup>(8)</sup>	<sup>(4)</sup>
		-200...0	0.05 °C + 0.04% RDG	0.07 °C + 0.06% RDG
		0...1000	0.05 °C + 0.003% RDG	0.07 °C + 0.005% RDG
J <sup>(3)</sup>	-210...1200	-210...-200	<sup>(8)</sup>	<sup>(4)</sup>
		-200...0	0.06 °C + 0.05% RDG	0.08 °C + 0.06% RDG
		0...1200	0.06 °C + 0.003% RDG	0.08 °C + 0.006% RDG
K <sup>(3)</sup>	-270...1372	-270...-200	<sup>(8)</sup>	<sup>(4)</sup>
		-200...0	0.08 °C + 0.07% RDG	0.1 °C + 0.1% RDG
		0...1000	0.08 °C + 0.004% RDG	0.1 °C + 0.007% RDG
		1000...1372	0.012% RDG	0.017% RDG
N <sup>(3)</sup>	-270...1300	-270...-200	<sup>(8)</sup>	<sup>(4)</sup>
		-200...-100	0.15% RDG	0.2% RDG
		-100...0	0.11 °C + 0.04% RDG	0.15 °C + 0.05% RDG
		0...800	0.11 °C	0.15 °C
		800...1300	0.06 °C + 0.006% RDG	0.07 °C + 0.01% RDG
T <sup>(3)</sup>	-270...400	-270...-200	<sup>(8)</sup>	<sup>(4)</sup>
		-200...0	0.07 °C + 0.07% RDG	0.1 °C + 0.1% RDG
		0...400	0.07 °C	0.1 °C
U <sup>(5)</sup>	-200...600	-200...0	0.07 °C + 0.05% RDG	0.1 °C + 0.07% RDG
		0...600	0.07 °C	0.1 °C
L <sup>(5)</sup>	-200...900	-200...0	0.06 °C + 0.025% RDG	0.08 °C + 0.04% RDG
		0...900	0.06 °C + 0.002% RDG	0.08 °C + 0.005% RDG
C <sup>(6)</sup>	0...2315	0...1000	0.22 °C	0.3 °C
		1000...2315	0.018% RDG	0.03 °C + 0.027% RDG
G <sup>(7)</sup>	0...2315	0...60	<sup>(8)</sup>	<sup>(4)</sup>
		60...200	0.9 °C	1.0 °C
		200...400	0.4 °C	0.5 °C
		400...1500	0.2 °C	0.3 °C
		1500...2315	0.014% RDG	0.02% RDG
D <sup>(6)</sup>	0...2315	0...140	0.3 °C	0.4 °C
		140...1200	0.2 °C	0.3 °C
		1200...2100	0.016% RDG	0.024% RDG
		2100...2315	0.45 °C	0.65 °C

Resolution 0.01°C.

With internal reference junction please see separate specification.

Also other thermocouple types available as option, please contact Beamex.

<sup>1)</sup> Accuracy includes hysteresis, nonlinearity and repeatability (k=2).

<sup>2)</sup> Uncertainty includes reference standard uncertainty, hysteresis, nonlinearity, repeatability and typical long term stability for mentioned period (k=2).

<sup>3)</sup> IEC 584, NIST MN 175, BS 4937, ANSI MC96.1

<sup>4)</sup> ±0.007% of thermovoltage + 4 µV

<sup>5)</sup> DIN 43710

<sup>6)</sup> ASTM E 988 - 96

<sup>7)</sup> ASTM E 1751 - 95e1

<sup>8)</sup> ±0.004% of thermovoltage + 3 µV

<b>Measurement input impedance</b>	> 10 MΩ
<b>Simulation maximum load current</b>	5 mA
<b>Simulation load effect</b>	< 5 µV/mA
<b>Supported units</b>	°C, °F, Kelvin, °Ré, °Ra
<b>Connector</b>	TC1: Universal TC connector , TC2: TC Miniplug

# RTD MEASUREMENT & SIMULATION

## R1 & R2 & R3 measurement

SENSOR TYPE	RANGE (°C)	RANGE (°C)	ACCURACY <sup>(1)</sup>	1 YEAR UNCERTAINTY (±) <sup>(2)</sup>
Pt50(385)	-200...850	-200...270 270...850	0.025 °C 0.009% RDG	0.03 °C 0.012% RDG
Pt100(375) Pt100(385) Pt100(389) Pt100(391) Pt100(3926)	-200...850	-200...0 0...850	0.011 °C 0.011 °C + 0.009% RDG	0.015 °C 0.015° + 0.012% RDG
Pt100(3923)	-200...600	-200...0 0...600	0.011 °C 0.011 °C + 0.009% RDG	0.015 °C 0.015 °C + 0.012% RDG
Pt200(385)	-200...850	-200...-80 -80...0 0...260 260...850	0.007 °C 0.016 °C 0.016 °C + 0.009% RDG 0.03 °C + 0.011% RDG	0.01 °C 0.02 °C 0.02 °C + 0.012% RDG 0.045 °C + 0.02% RDG
Pt400(385)	-200...850	-200...-100 -100...0 0...850	0.007 °C 0.015 °C 0.026 °C + 0.01% RDG	0.01 °C 0.02 °C 0.045 °C + 0.019% RDG
Pt500(385)	-200...850	-200...-120 -120...-50 -50...0 0...850	0.008 °C 0.013 °C 0.025 °C 0.025 °C + 0.01% RDG	0.01 °C 0.02 °C 0.045 °C 0.045 °C + 0.019% RDG
Pt1000(385)	-200...850	-200...-150 -150...-50 -50...0 0...850	0.007 °C 0.018 °C 0.022 °C 0.022 °C + 0.01% RDG	0.008 °C 0.03 °C 0.04 °C 0.04 °C + 0.019% RDG
Ni100(618)	-60...180	-60...0 0...180	0.009 °C 0.009 °C + 0.005% RDG	0.012 °C 0.012 °C + 0.006% RDG
Ni120(672)	-80...260	-80...0 0...260	0.009 °C 0.009 °C + 0.005% RDG	0.012 °C 0.012 °C + 0.006% RDG
Cu10(427)	-200...260	-200...260	0.012 °C	0.16 °C

Measurement channel R3 is operational only when the mains power is connected.

## R1 Simulation

SENSOR TYPE	RANGE (°C)	RANGE (°C)	ACCURACY <sup>(1)</sup>	1 YEAR UNCERTAINTY (±) <sup>(2)</sup>
Pt50(385)	-200...850	-200...270 270...850	0.055 °C 0.035 °C + 0.008% RDG	0.11 °C 0.11 °C + 0.015% RDG
Pt100(375) Pt100(385) Pt100(389) Pt100(391) Pt100(3926)	-200...850	-200...0 0...850	0.025 °C 0.025 °C + 0.007% RDG	0.05 °C 0.05 °C + 0.014% RDG
Pt100(3923)	-200...600	-200...0 0...600	0.025 °C 0.025 °C + 0.007% RDG	0.05 °C 0.05 °C + 0.014% RDG
Pt200(385)	-200...850	-200...-80 -80...0 0...260 260...850	0.012 °C 0.02 °C 0.02 °C + 0.006% RDG 0.03 °C + 0.011% RDG	0.025 °C 0.035 °C 0.04 °C + 0.011% RDG 0.06 °C + 0.02% RDG
Pt400(385)	-200...850	-200...-100 -100...0 0...850	0.01 °C 0.015 °C 0.027 °C + 0.01% RDG	0.015 °C 0.03 °C 0.05 °C + 0.019% RDG
Pt500(385)	-200...850	-200...-120 -120...-50 -50...0 0...850	0.008 °C 0.012 °C 0.026 °C 0.026 °C + 0.01% RDG	0.015 °C 0.025 °C 0.05 °C 0.05 °C + 0.019% RDG
Pt1000(385)	-200...850	-200...-150 -150...-50 -50...0 0...850	0.006 °C 0.017 °C 0.023 °C 0.023 °C + 0.01% RDG	0.011 °C 0.03 °C 0.043 °C 0.043 °C + 0.019% RDG
Ni100(618)	-60...180	-60...0 0...180	0.021 °C 0.019 °C	0.042 °C 0.037 °C + 0.001% RDG
Ni120(672)	-80...260	-80...0 0...260	0.021 °C 0.019 °C	0.042 °C 0.037 °C + 0.001% RDG
Cu10(427)	-200...260	-200...260	0.26 °C	0.52 °C

For platinum sensors ITS-90 and Callendar van Dusen coefficients can be programmed. Also other RTD types available as option, please contact Beamex.

FEATURE	SPECIFICATION
RTD Measurement current	Pulsed, bi-directional 1 mA (0..500 Ω), 0.2 mA (> 500 Ω)
4-wire connection	Measurement specifications valid
3-wire measurement	Add 10 mΩ
Max resistance excitation current	5 mA (0...650 Ω). $I_{exc} \times R_{sim} < 3.25 \text{ V}$ (650...4000 Ω)
Min resistance excitation current	> 0.2 mA (0...400 Ω). > 0.1 mA (400...4000 Ω)
Simulation settling time with pulsed excitation current	< 1 ms
Supported units	°C, °F, Kelvin, °Ré, °Ra

## Internal reference junction TC1 & TC2

RANGE (°C)	ACCURACY <sup>(1)</sup>	1 YEAR UNCERTAINTY <sup>(2)</sup>
0...45 °C	±0.10 °C	±0.15 °C

Specifications valid in temperature range: 15...35 °C.

Temperature coefficient outside of 15...35 °C: ±0.005 °C/ °C.

Specifications assumes that calibrator has stabilized in environmental condition, being switched on, for minimum of 90 minutes. For a measurement or simulation done sooner than that, please add uncertainty of 0.15 °C.

In order to calculate the total uncertainty of thermocouple measurement or simulation with internal reference junction used, please add the relevant thermocouple uncertainty and the reference junction uncertainty together as a root sum of the squares.

92

## VOLTAGE MEASUREMENT

### IN (-1...60 V)

RANGE	RESOLUTION	ACCURACY <sup>(1)</sup>	1 YEAR UNCERTAINTY <sup>(2)</sup>
-1.01...1 V	0.001 mV	3 μV + 0.003% RDG	5 μV + 0.006% RDG
1...10 V	0.01 mV	0.125 mV + 0.003% RDG	0.25 mV + 0.006% RDG
10...60.6 V	0.1 mV	0.125 mV + 0.003% RDG	0.25 mV + 0.006% RDG

<b>Input impedance</b>	> 2 MΩ
<b>Supported units</b>	V, mV, μV

### TC1 & TC2 (-1...1 V)

RANGE	RESOLUTION	ACCURACY <sup>(1)</sup>	1 YEAR UNCERTAINTY <sup>(2)</sup>
-1.01...1.01 V	0.001 mV	3 μV + 0.004% RDG	4 μV + 0.007% RDG

<b>Input impedance</b>	> 10 MΩ
<b>Supported units</b>	V, mV, μV
<b>Connector</b>	TC1: Universal TC connector , TC2: TC Miniplug

<sup>1)</sup> Accuracy includes hysteresis, nonlinearity and repeatability (k=2).

<sup>2)</sup> Uncertainty includes reference standard uncertainty, hysteresis, nonlinearity, repeatability and typical long term stability for mentioned period (k=2).

## VOLTAGE GENERATION

### OUT (-3...24 V)

RANGE	RESOLUTION	ACCURACY <sup>(1)</sup>	1 YEAR UNCERTAINTY <sup>(2)</sup>
-3...10 V	0.00001 V	0.05 mV + 0.004% RDG	0.1 mV + 0.007% RDG
10...24 V	0.0001 V	0.05 mV + 0.004% RDG	0.1 mV + 0.007% RDG
<b>Maximum load current</b>		10 mA	
<b>Short circuit current</b>		>100 mA	
<b>Load effect</b>		< 50 $\mu$ V/mA	
<b>Supported units</b>		V, mV, $\mu$ V	

### TC1 (-1...1 V)

RANGE	RESOLUTION	ACCURACY <sup>(1)</sup>	1 YEAR UNCERTAINTY <sup>(2)</sup>
-1...1 V	0.001 mV	3 $\mu$ V + 0.004% RDG	4 $\mu$ V + 0.007% RDG
<b>Maximum load current</b>		5 mA	
<b>Load effect</b>		< 5 $\mu$ V/mA	
<b>Supported units</b>		V, mV, $\mu$ V	

93

## CURRENT MEASUREMENT

### IN (-100...100 mA)

RANGE	RESOLUTION	ACCURACY <sup>(1)</sup>	1 YEAR UNCERTAINTY <sup>(2)</sup>
-25...25 mA	0.0001 mA	0.75 $\mu$ A + 0.0075% RDG	1 $\mu$ A + 0.01% RDG
$\pm$ (25...101 mA)	0.001 mA	0.75 $\mu$ A + 0.0075% RDG	1 $\mu$ A + 0.01% RDG
<b>Input impedance</b>		< 10 $\Omega$	
<b>Supported units</b>		mA, $\mu$ A	
<b>Loop supply</b>		Internal 24 V $\pm$ 10% (max 55 mA), or external max 60 VDC	

## CURRENT GENERATION

### OUT (0...55 mA)

RANGE	RESOLUTION	ACCURACY <sup>(1)</sup>	1 YEAR UNCERTAINTY <sup>(2)</sup>
0...25 mA	0.0001 mA	0.75 $\mu$ A + 0.0075% RDG	1 $\mu$ A + 0.01% RDG
25...55 mA	0.001 mA	1.5 $\mu$ A + 0.0075% RDG	2 $\mu$ A + 0.01% RDG
<b>Internal loop supply</b>		24 V $\pm$ 5%. Max 55 mA.	
<b>Max load impedance w. internal supply</b>		24 V / (generated current). 1140 $\Omega$ @ 20 mA, 450 $\Omega$ @ 50 mA	
<b>Max external loop supply</b>		60 VDC	
<b>Supported units</b>		mA, $\mu$ A	

<sup>1)</sup> Accuracy includes hysteresis, nonlinearity and repeatability (k=2).

<sup>2)</sup> Uncertainty includes reference standard uncertainty, hysteresis, nonlinearity, repeatability and typical long term stability for mentioned period (k=2).

# FREQUENCY MEASUREMENT

## IN (0.0027...50000 Hz)

RANGE	RESOLUTION	ACCURACY <sup>(1)</sup>	1 YEAR UNCERTAINTY <sup>(2)</sup>
0.0027...0.5 Hz	0.000001 Hz	0.000002 Hz + 0.001% RDG	0.000002 Hz + 0.002% RDG
0.5...5 Hz	0.00001 Hz	0.00002 Hz + 0.001% RDG	0.00002 Hz + 0.002% RDG
5...50 Hz	0.0001 Hz	0.0002 Hz + 0.001% RDG	0.0002 Hz + 0.002% RDG
50...500 Hz	0.001 Hz	0.002 Hz + 0.001% RDG	0.002 Hz + 0.002% RDG
500...5000 Hz	0.01 Hz	0.02 Hz + 0.001% RDG	0.02 Hz + 0.002% RDG
5000...51000 Hz	0.1 Hz	0.2 Hz + 0.001% RDG	0.2 Hz + 0.002% RDG

<b>Input impedance</b>	>1 MΩ
<b>Supported units</b>	Hz, kHz, cph, cpm, 1/Hz(s), 1/kHz(ms), 1/MHz(μs)
<b>Trigger level</b>	Dry contact, wet contact -1...14 V
<b>Minimum signal amplitude</b>	1.0 Vpp (<10kHz), 1.2 Vpp (10...50 kHz)

# FREQUENCY GENERATION

## OUT (0.0005...50000 Hz)

RANGE	RESOLUTION	ACCURACY <sup>(1)</sup>	1 YEAR UNCERTAINTY <sup>(2)</sup>
0.0005...0.5 Hz	0.000001 Hz	0.000002 Hz + 0.001% RDG	0.000002 Hz + 0.002% RDG
0.5...5 Hz	0.00001 Hz	0.00002 Hz + 0.001% RDG	0.00002 Hz + 0.002% RDG
5...50 Hz	0.0001 Hz	0.0002 Hz + 0.001% RDG	0.0002 Hz + 0.002% RDG
50...500 Hz	0.001 Hz	0.002 Hz + 0.001% RDG	0.002 Hz + 0.002% RDG
500...5000 Hz	0.01 Hz	0.02 Hz + 0.001% RDG	0.02 Hz + 0.002% RDG
5000...50000 Hz	0.1 Hz	0.2 Hz + 0.001% RDG	0.2 Hz + 0.002% RDG

<b>Maximum load current</b>	10 mA
<b>Wave forms</b>	Positive square, symmetric square
<b>Output amplitude positive square wave</b>	0...24 Vpp
<b>Output amplitude symmetric square wave</b>	0...6 Vpp
<b>Duty Cycle</b>	1...99%
<b>Amplitude accuracy</b>	< 5% of amplitude
<b>Supported units</b>	Hz, kHz, cph, cpm, 1/Hz(s), 1/kHz(ms), 1/MHz(μs)

# PULSE COUNTING

## IN (0...9 999 999 pulses)

FEATURE	SPECIFICATION
Input impedance	>1 MΩ
Trigger level	Dry contact, wet contact -1...14 V
Minimum signal amplitude	1 Vpp (< 10 kHz), 1.2 Vpp (10...50 kHz)
Max frequency	50 kHz
Trigger edge	Rising, falling

<sup>1)</sup> Accuracy includes hysteresis, nonlinearity and repeatability (k=2).

<sup>2)</sup> Uncertainty includes reference standard uncertainty, hysteresis, nonlinearity, repeatability and typical long term stability for mentioned period (k=2).

# PULSE GENERATION

## OUT (0...9 999 999 pulses)

FEATURE	SPECIFICATION
Resolution	1 pulse
Maximum load current	10 mA
Output amplitude positive pulse	0...24 Vpp
Output amplitude symmetric pulse	0...6 Vpp
Pulse frequency range	0.0005...10000 Hz
Duty cycle	1...99%

# RESISTANCE MEASUREMENT

## R1 & R2 & R3 (0...4000 Ω)

RANGE	RESOLUTION	ACCURACY <sup>(1)</sup>	1 YEAR UNCERTAINTY <sup>(2)</sup>
-1...100 Ω	0.001 Ω	4.5 mΩ	6 mΩ
100...110 Ω	0.001 Ω	0.0045% RDG	0.006% RDG
110...150 Ω	0.001 Ω	0.005% RDG	0.007% RDG
150...300 Ω	0.001 Ω	0.006% RDG	0.008% RDG
300...400 Ω	0.001 Ω	0.007% RDG	0.009% RDG
400...4040 Ω	0.01 Ω	9 mΩ + 0.008% RDG	12 mΩ + 0.015% RDG

<b>Measurement current</b>	Pulsed, bi-directional 1 mA (0..500 Ω), 0.2 mA (>500 Ω)
<b>Supported units</b>	Ω, kΩ
<b>4-wire connection</b>	Measurement specifications valid
<b>3-wire measurement</b>	Add 10 mΩ

Measurement channel R3 is operational only when the mains power is connected.

# RESISTANCE SIMULATION

## R1 (0...4000 Ω)

RANGE	RESOLUTION	ACCURACY <sup>(1)</sup>	1 YEAR UNCERTAINTY <sup>(2)</sup>
0...100 Ω	0.001 Ω	10 mΩ	20 mΩ
100...400 Ω	0.001 Ω	5 mΩ + 0.005% RDG	10 mΩ + 0.01% RDG
400...4000 Ω	0.01 Ω	10 mΩ + 0.008% RDG	20 mΩ + 0.015% RDG

<b>Max resistance excitation current</b>	5 mA (0...650 Ω). $I_{exc} \times R_{sim} < 3.25 \text{ V}$ (650...4000 Ω)
<b>Min resistance excitation current</b>	> 0.2 mA (0...400 Ω). >0.1 mA (400...4000 Ω)
<b>Settling time with pulsed excitation current</b>	< 1ms
<b>Supported units</b>	Ω, kΩ

<sup>1)</sup> Accuracy includes hysteresis, nonlinearity and repeatability (k=2).

<sup>2)</sup> Uncertainty includes reference standard uncertainty, hysteresis, nonlinearity, repeatability and typical long term stability for mentioned period (k=2).

# Inserts

## Inserts for MC6-T150

INSERT	DESCRIPTION
MC6-T150 MH1	Multi-hole (3mm, 4mm, 6mm, 8mm, 10mm, 1/4in), comes with two rubber shields
MC6-T150 MH2	Multi-hole (2×3mm, 2×4mm, 6mm, 1/4in), comes with two rubber shields
MC6-T150 MH3	Multi-hole (3×1/4in, 3/16in, 1/8in, 3/8in, 3mm), comes with two rubber shields
MC6-T150 MH4	Multi-hole (2×1/4in, 2×3/16in, 2×3/8in, 3mm), comes with two rubber shields
MC6-T150 B	Blank insert, comes with two blank rubber shields
MC6-T150 S	Special insert. Multiple special inserts available on request, comes with two blank rubber shields
SANITARY BLANK INSERT	Blank insert for short tri-clamp sanitary sensor

Please contact Beamex for custom inserts.

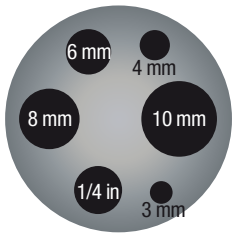

MC6-T150 MH1

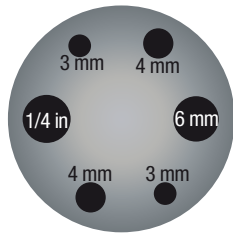

MC6-T150 MH2

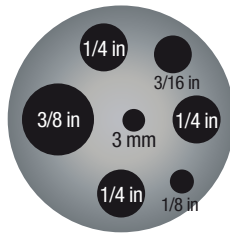

MC6-T150 MH3

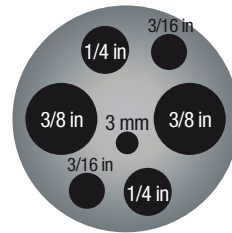

MC6-T150 MH4

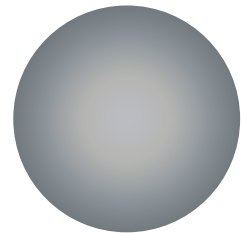

MC6-T150 B

96

## Inserts for MC6-T660

INSERT	DESCRIPTION
MC6-T660 MH1	Multi-hole (3mm, 6mm, 8mm, 10mm, 1/4in)
MC6-T660 MH2	Multi-hole (2×3mm, 2×4mm, 6mm, 1/4in)
MC6-T660 MH3	Multi-hole (2×1/4in, 3/16in, 3/8in, 3mm)
MC6-T660 MH4	Multi-hole (2×1/4in, 2×3/16in, 3/8in, 3mm)
MC6-T660 B	Blank insert
MC6-T660 S	Special insert. Multiple special inserts available on request.

Please contact Beamex for custom inserts.

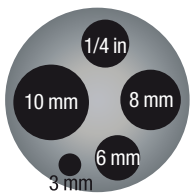

MC6-T660 MH1

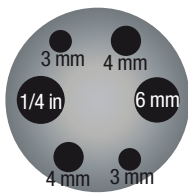

MC6-T660 MH2

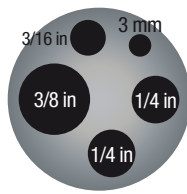

MC6-T660 MH3

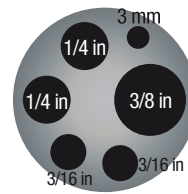

MC6-T660 MH4

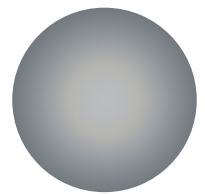

MC6-T660 B



# Modularity, options and accessories

## MODULARITY AND OPTIONS

- Hardware options:
  - Internal barometric pressure module.
- Firmware options:
  - Data Logger user interface mode
  - HART communicator
  - FOUNDATION Fieldbus communicator
  - Profibus PA communicator
- Pressure and temperature controller communications (please check Beamex for supported models)
- Optional RTD and thermocouple sensor types (please contact Beamex for supported types)



## STANDARD ACCESSORIES

- Power cord
- USB cable
- Test clips type 1, 1 pair
- Test clips type 2, 2 pairs
- Test lead Cu-Cu
- Test leads, 3 pairs
- Insert removal tool
- User guide in English
- Accredited calibration certificate

## OPTIONAL ACCESSORIES

- Accessory holder kit for MC6-T150
- Accessory holder kit for MC6-T660
- Transport case
- RPRT reference probe
- IPRT Industrial Platinum Resistance Thermometer
- SIRT Short Industrial Resistance Thermometer
- Connector set for barewire applications, 4 pcs.
- Thermocouple plug set, including: R/S, E, J, K, N, T-types. ANSI.
- Thermocouple plug set, including: R/S, E, J, K, N, T-types. IEC.
- Test lead set with 7/8" connector for Foundation Fieldbus.
- Test lead set with M12 connector for Foundation Fieldbus.
- Test lead set with 7/8" connector for Profibus PA.
- Test lead set with M12 connector for Profibus PA.
- EXT pressure module cable.
- Adapter cable to Beamex RPRT sensors, 6-pin female Lemo to banana plugs.
- Adapter cable to MC6 R2-channel or R-model temperature block, Banana plugs to 6-pin male Lemo.



# Beamex MC6-T

## MULTIFUNCTION TEMPERATURE CALIBRATOR AND COMMUNICATOR

### Versatile

The Beamex MC6-T is an extremely versatile portable automated temperature calibration system. It combines a state-of-the-art temperature dry-block with Beamex MC6 multifunction process calibrator technology. It offers versatility, that no other temperature calibrator can match.

### Multifunctional

With the ability to generate temperature as well as measure and simulate temperature and electrical signals, it offers a really unique combination of functionality. In addition to temperature calibration abilities, the MC6-T also offers electrical and pressure calibration capability, all in one device.

### Great metrological performance

The MC6-T provides superior metrological performance and accuracy for temperature calibrations, while being robust, light and easy to carry field calibrator.

### Made for industrial use

The calibrator is designed for industrial environments and it is designed to minimize the impact of varying environmental conditions and AC power fluctuations.

### Enhanced usability

A large multilingual color touch screen, combined with numerical and graphical views, provides an easy to use system available in multiple languages.

### Field communicator

The MC6-T has a built-in field communicator for HART, FOUNDATION Fieldbus H1 and Profibus PA instruments. This enables calibration, configuration and trimming of modern smart instruments with a single device, without the need to carry a separate field communicator.

### Documenting calibrator

MC6-T is a documenting calibrator that communicates with calibration management software to enable a fully digitalized, paperless calibration process and documentation database.



### Main features

- ▶ Versatile temperature calibration system
- ▶ Excellent accuracy and metrological performance
- ▶ Great usability
- ▶ Extensive process calibrator functionality
- ▶ Made for industrial field use
- ▶ Includes a multibus field communicator
- ▶ Automatic documenting calibrator – digitalize your calibration process



# Beamex MB

METROLOGY TEMPERATURE BLOCK



Portable temperature dry block delivering bath-level accuracy for industrial applications

**beamex**  
A BETTER WAY TO CALIBRATE

79877348759834759833  
87984654546546  
7987465465465132132131  
6545879565836458734657  
655387875684653403

# Highly accurate temperature dry block

100



# Portable temperature dry block delivering bath-level accuracy for industrial applications

The Beamex metrology temperature block (MB) is a user friendly and highly accurate temperature dry block. It delivers bath-level accuracy in a convenient dry block with temperature ranges from  $-45\text{ °C}$  ...  $+700\text{ °C}$ . It enables you to take laboratory-level accuracy with you out into the field.

## Main features of MB

### High accuracy and stability

With a conventional dry block, you typically needed an external reference sensor if you wanted better accuracy. The Beamex MB has accurate internal temperature measurement and display accuracy up to  $\pm 0.1\text{ °C}$ , so you can get high accuracy even without an external reference sensor. With the unique temperature control techniques the Beamex<sup>®</sup> MB has excellent stability up to  $\pm 0.005\text{ °C}$ . This kind of stability has usually been found only in baths, not in dry blocks.

### Built-in high-accuracy reference input

In order to receive the best accuracy from the MB, there is a possibility to connect an external reference sensor into the reference sensor connection (R model). This eliminates the need for a separate reference thermometer. The reference sensor measurement is accurate up to  $\pm 0.006\text{ °C}$ . ITS-90 or CVD coefficients can be used to compensate any sensor errors.

### Axial uniformity

With the unique dual zone control and extended well depth, the Beamex MB has an excellent axial uniformity up to  $\pm 0.02\text{ °C}$ .

### Radial uniformity

Radial uniformity is the temperature difference between the holes in the insert. It is naturally crucial that the reference sensor and the sensor being tested are at the same temperature. The Beamex MB offers radial uniformity up to  $\pm 0.01\text{ °C}$ .

### Immersion Depth

The Beamex MB series provides immersion depth up to 203 mm (160 mm in MB140), which, together with the control techniques, provides more stable calibration. Moreover, a deeper immersion depth reduces the stem conduction error (heat loss into the atmosphere), especially in higher temperatures.

### Loading

With the extended well depth and the dual zone temperature control feature, the Beamex MB can correct the effect of loading and provides loading specifications up to  $\pm 0.005\text{ °C}$ .



# Beamex MB series specifications

	MB140	MB155	MB425	MB700
<b>Temperature range at 23 °C</b>	-45 °C to 140 °C (-49 °F to 284 °F)	-30 °C to 155 °C (-22 °F to 311 °F)	35 °C to 425 °C (95 °F to 797 °F)	50 °C to 700 °C <sup>3)</sup> (122 °F to 1292 °F)
<b>Display accuracy</b>	±0.1 °C Full range	±0.1 °C Full range	±0.1 °C to 100 °C ±0.15 °C to 225 °C ±0.2 °C to 425 °C	±0.2 °C to 425 °C ±0.25 °C to 660 °C
<b>Stability</b>	±0.005 °C Full range	±0.005 °C Full range	±0.005 °C to 100 °C ±0.008 °C to 225 °C ±0.01 °C to 425 °C	±0.005 °C to 100 °C ±0.01 °C to 425 °C ±0.03 °C to 700 °C
<b>Axial uniformity 40 mm (1.6 in)</b>	±0.08 °C to -35 °C ±0.04 °C to 0 °C ±0.02 °C to 50 °C ±0.07 °C to 140 °C	±0.025 °C to 0 °C ±0.02 °C to 50 °C ±0.05 °C to 155 °C	±0.05 °C to 100 °C ±0.09 °C to 225 °C ±0.17 °C to 425 °C	±0.09 °C to 100 °C ±0.22 °C to 425 °C ±0.35 °C to 700 °C
<b>Radial uniformity</b>	±0.01 °C Full range	±0.01 °C Full range	±0.01 °C to 100 °C ±0.02 °C to 225 °C ±0.025 °C to 425 °C	±0.01 °C to 100 °C ±0.025 °C to 425 °C ±0.04 °C to 700 °C
<b>Loading effect (with a 6.35 mm reference probe and three 6.35 mm probes)</b>	±0.02 °C to -35 °C ±0.005 °C to 100 °C ±0.01 °C to 140 °C	±0.005 °C to 0 °C ±0.005 °C to 100 °C ±0.01 °C to 155 °C	±0.01 °C Full range	±0.02 °C to 425 °C ±0.04 °C to 700 °C
<b>Hysteresis</b>	±0.025 °C	±0.025 °C	±0.04 °C	±0.07 °C
<b>Immersion depth</b>	160 mm (6.3 in)	203 mm (8 in)	203 mm (8 in)	203 mm (8 in)
<b>Resolution</b>	0.001 °C / °F			
<b>Display</b>	LCD, °C or °F, user-selectable			
<b>Key pad</b>	Ten key with decimal and +/- button. Function keys, menu key, and °C / °F key.			
<b>Insert OD dimensions</b>	30.0 mm (1.18 in)	30.0 mm (1.18 in)	30.0 mm (1.18 in)	29.2 mm (1.15 in)
<b>Cooling time</b>	44 min: 23 °C to -45 °C 19 min: 23 °C to -30 °C 19 min: 140 °C to 23 °C	30 min: 23 °C to -30 °C 25 min: 155 °C to 23 °C	220 min: 425 °C to 35 °C 100 min: 425 °C to 100 °C	235 min: 700 °C to 50 °C 153 min: 700 °C to 100 °C
<b>Heating time</b>	32 min: 23 °C to 140 °C 45 min: -45 °C to 140 °C	44 min: 23 °C to 155 °C 56 min: -30 °C to 155 °C	27 min: 35 °C to 425 °C	46 min: 50 °C to 700 °C
<b>Size (H x W x D)</b>	366 x 203 x 323 mm (14.4 x 8 x 12.7 in)			
<b>Weight</b>	14.2 kg (31.5 lb)	14.6 kg (32 lb)	12.2 kg (27 lb)	14.2 kg (31.5 lb)
<b>Power requirements</b>	230 VAC (±10%), 550 W 115 VAC (±10%), 550 W	230 VAC (±10%), 550 W 115 VAC (±10%), 550 W	230 VAC (±10%), 1025 W 115 VAC (±10%), 1025 W	230 VAC (±10%), 1025 W 115 VAC (±10%), 1025 W
<b>Computer interface</b>	RS-232			
<b>Calibration</b>	Accredited calibration certificate provided			
<b>Environmental operating conditions</b>	5 °C to 40 °C, 0% to 80% RH (non-condensing)			
<b>Specifications valid in environmental conditions</b>	18 °C...28 °C			
<b>Warranty</b>	Warranty 1 Year			

3) Calibrated to 660 °C; reference thermometer recommended at higher temperatures.

R MODEL SPECIFICATIONS	MB
<b>Resistance range</b>	0 Ω to 400 Ω
<b>Resistance accuracy <sup>1)</sup></b>	0 Ω to 20 Ω: ±0.0005 Ω 20 Ω to 400 Ω: ±25 ppm of reading
<b>Characterizations</b>	ITS-90, CVD, Resistance
<b>Temperature accuracy (100 Ω PRT) <sup>2)</sup></b>	Below zero: ±(0.006 °C + 0.001% of temperature reading) Above zero: ±(0.006 °C + 0.003% of temperature reading)
<b>Sensor connection</b>	4-wire, 6-pin Lemo
<b>Calibration</b>	Accredited calibration certificate provided

1) Measurement accuracy specifications apply within the specified environmental operating conditions and assume 4-wires for PRTs.

2) The built-in reference thermometer readout accuracy does not include the sensor probe accuracy.

# Inserts

## INSERTS FOR MB MODELS

INSERT	MODEL	DESCRIPTION
MH1	All models	Multihole, metric / reference; ¼", 3 mm, 4 mm, 6 mm, 8 mm, 10 mm
MH2	All models	Multihole, metric / reference; ¼", 2x3 mm, 2x4 mm, 6 mm
B	All models	Blank
Special	All models	Special

Please contact Beamex for custom inserts.

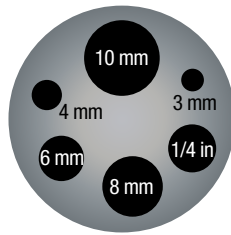

MH1

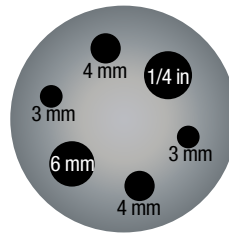

MH2

## STANDARD ACCESSORIES

- Power Cord
- RS-232 Cable
- User Guide
- Accredited Calibration Certificate
- LEMO Connector for reference sensor (R models only)
- Block Insulator (in MB140, MB155 and MB425)
- Tongs (insert removal tool)

## OPTIONAL ACCESSORIES

- Transport Case for temperature block
- Inserts

# Beamex MB

## METROLOGY TEMPERATURE BLOCK

104

The Beamex metrology temperature block (MB) is a highly accurate temperature dry block. It delivers bath-level accuracy in a convenient dry block. It enables you to take laboratory level accuracy with you out into the field. The unique dual zone control technology enables excellent stability and uniformity. Immersion depth up to 203 mm and temperature ranges from  $-45\text{ °C}$  ...  $+700\text{ °C}$ .

### Compact and user-friendly

The MB is a compact, lightweight, portable calibrator with a large graphical display, multilingual interface and full numerical keyboard. Calibration is quick and simple.

### Accuracy guaranteed

- MB140 / MB140R with range  $-45\text{ °C}$  ...  $+140\text{ °C}$
- MB155 / MB155R with range  $-30\text{ °C}$  ...  $+155\text{ °C}$
- MB425 / MB425R with range  $+35\text{ °C}$  ...  $+425\text{ °C}$
- MB700 / MB700R with range  $+50\text{ °C}$  ...  $+700\text{ °C}$

The R models include an internal reference thermometer with a connection for an external reference sensor.

### Smart reference probes

Beamex smart reference probes are high-quality and extremely stable reference PRT probes with an integrated memory to store the individual probe coefficients. They are available in two versions: 300 mm straight version or a  $90^\circ$  bent version.



### Main features

- ▶ High accuracy – a dry block that delivers bath-level accuracy
- ▶ The unique dual zone control technology enables excellent stability and uniformity
- ▶ Immersion depth up to 203 mm
- ▶ Wide temperature range from  $-45\text{ °C}$  to  $+700\text{ °C}$
- ▶ Accredited calibration as standard
- ▶ Part of the Beamex integrated calibration solution



# Beamex FB

FIELD TEMPERATURE BLOCK



Lightweight, highly accurate temperature dry block for industrial field use

**beamex**  
A BETTER WAY TO CALIBRATE

79877348759834759833  
87984654546546  
7987465465465132132131  
6545879565836458734657  
655387875684653403

# An ideal temperature block for industrial field use



# Lightweight, highly accurate temperature dry block for industrial field use

The Beamex field temperature block (FB) is an ideal temperature block for industrial field use. It is lightweight and easy to carry. It is an extremely quick dry block, yet it provides excellent accuracy.

## Main features of the Beamex FB

### Lightweight, portable

The Beamex FB field temperature block is ideal for industrial field use. It only weighs about 8 kg, and it is small enough to carry around.

### Speed

The Beamex FB is extremely quick to reach various temperatures, i.e. it cools down to  $-25\text{ }^{\circ}\text{C}$  in 15 minutes and heats up to  $+660\text{ }^{\circ}\text{C}$  in 15 minutes. This saves time and increases productivity.

### Accuracy and performance

The Beamex FB is an easily portable unit that also provides excellent calibration accuracy. The display accuracy is up to  $\pm 0.2\text{ }^{\circ}\text{C}$  and its control technology provides great stability up to  $\pm 0.01\text{ }^{\circ}\text{C}$ . The dual zone controlled block provides excellent axial uniformity up to  $\pm 0.04\text{ }^{\circ}\text{C}$  and radial uniformity up to  $\pm 0.01\text{ }^{\circ}\text{C}$ .

### Smart reference sensors

The Beamex FB has an internal reference thermometer (in R models), which enables connections to the Beamex smart reference sensors. These sensors have a memory that contains all of the sensor correction data. This enables the use of the reference sensor as a real plug-and-play.

### Accredited calibration

Each Beamex FB field temperature block is delivered with an accredited calibration certificate.

### Usability

The large LCD display, function keys and multilingual, menu-based user interface makes the Beamex FB easy to use. A graphic and audible stability indicator lets you know when a block is stable. The HOT warning light indicates when the block is hot (over  $+50\text{ }^{\circ}\text{C}$ ). It blinks as long as the block is too hot to touch, even when the unit is switched off or when the mains cable is disconnected.

### Part of the Beamex ICS integrated calibration solution

The communication port enables communication with selected Beamex MC calibrators for automation calibration and documentation, making the Beamex FB products part of the Beamex ICS integrated calibration solution. Combined with the Beamex MC6 calibrator, loop calibrations are possible with conventional, HART and Fieldbus temperature transmitters with sensors.



# Beamex FB series specifications

	FB150	FB350	FB660
<b>Temperature range at 23 °C</b>	-25 °C to 150 °C (-13 °F to 302 °F)	33 °C to 350 °C (91 °F to 662 °F)	50 °C to 660 °C (122 °F to 1220 °F)
<b>Display accuracy</b>	±0.2 °C Full range	±0.2 °C Full range	±0.35 °C at 50 °C ±0.35 °C at 420 °C ±0.5 °C at 660 °C
<b>Stability</b>	±0.01 °C Full range	±0.02 °C at 33 °C ±0.02 °C at 200 °C ±0.03 °C at 350 °C	±0.03 °C at 50 °C ±0.05 °C at 420 °C ±0.05 °C at 660 °C
<b>Axial uniformity at 40 mm (1.6 in)</b>	±0.05 °C Full range	±0.04 °C at 33 °C ±0.1 °C at 200 °C ±0.2 °C at 350 °C	±0.05 °C at 50 °C ±0.35 °C at 420 °C ±0.5 °C at 660 °C
<b>Radial uniformity</b>	±0.01 °C Full range	±0.01 °C at 33 °C ±0.015 °C at 200 °C ±0.02 °C at 350 °C	±0.02 °C at 50 °C ±0.05 °C at 420 °C ±0.10 °C at 660 °C
<b>Loading effect (with a 6.35 mm reference probe and three 6.35 mm probes)</b>	±0.006 °C Full range	±0.015 °C Full range	±0.015 °C at 50 °C ±0.025 °C at 420 °C ±0.035 °C at 660 °C
<b>Hysteresis</b>	±0.025 °C	±0.06 °C	±0.2 °C
<b>Immersion depth</b>	150 mm (5.9 in)		
<b>Insert OD dimensions</b>	30 mm (1.18 in)	25.3 mm (0.996 in)	24.4 mm (0.96 in)
<b>Heating time</b>	16 min: 23 °C to 140 °C 23 min: 23 °C to 150 °C 25 min: -25 °C to 150 °C	5 min: 33 °C to 350 °C	15 min: 50 °C to 660 °C
<b>Cooling time</b>	15 min: 23 °C to -25 °C 25 min: 150 °C to -25 °C	32 min: 350 °C to 33 °C 14 min: 350 °C to 100 °C	35 min: 660 °C to 50 °C 25 min: 660 °C to 100 °C
<b>Resolution</b>	0.01 °C / °F		
<b>Display</b>	LCD, °C or °F user-selectable		
<b>Size (H x W x D)</b>	290 mm x 185 mm x 295 mm (11.4 x 7.3 x 11.6 in)		
<b>Weight</b>	8.16 kg (18 lb)	7.3 kg (16 lb)	7.7 kg (17 lb)
<b>Power requirements</b>	230 V (±10%) 50/60 Hz, 575 W 100 V to 115 V (±10%) 50/60 Hz, 635 W	230 V (±10%), 50/60 Hz, 1800 W 100 V to 115 V (±10%), 50/60 Hz, 1400 W	230 V (±10%), 50/60 Hz, 1800 W 100 V to 115 V (±10%), 50/60 Hz, 1400 W
<b>Computer interface</b>	RS-232	RS-232	RS-232
<b>Calibration</b>	Accredited calibration certificate provided		
<b>Environmental operating conditions</b>	0 °C to 50 °C, 0% to 90% RH (non-condensing)		
<b>Specifications valid in environmental conditions</b>	13 °C...33 °C		
<b>Warranty</b>	Warranty 1 Year		

108

R MODEL SPECIFICATIONS	FB
<b>Resistance range</b>	0 Ω to 400 Ω
<b>Resistance accuracy <sup>1)</sup></b>	0 Ω to 42 Ω: ±0.0025 Ω 42 Ω to 400 Ω: ±60 ppm of reading
<b>Characterizations</b>	ITS-90, CVD, IEC-60751, resistance
<b>Temperature accuracy (100 Ω PRT) <sup>2)</sup></b>	±(0.015 °C + 0.008% of temperature reading)
<b>Sensor connection</b>	4-wire, 6-pin Smart Lemo
<b>Calibration</b>	Accredited calibration certificate provided

1) Measurement accuracy specifications apply within the specified environmental operating conditions and assume 4-wires for PRTs.

2) The built-in reference thermometer readout accuracy does not include the sensor probe accuracy.

# Inserts

## INSERTS FOR FB MODELS

INSERT	MODEL	DESCRIPTION
MH1	FB150	Multihole, metric / reference; ¼", 3 mm, 4 mm, 6 mm, 8 mm, 10 mm
MH1	FB350, FB660	Multihole, metric / reference; ¼", 4 mm, 6 mm, 8 mm, 10 mm
MH2	All models	Multihole, metric / reference; ¼", 2x3 mm, 2x4 mm, 6 mm
B	All models	Blank
Special	All models	Special

Please contact Beamex for custom inserts.

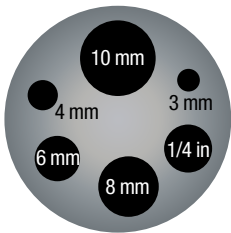

FB150-MH1

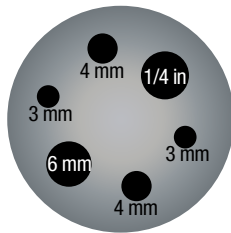

FB150-MH2

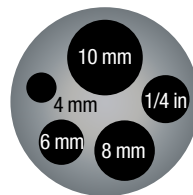

FB350-MH1, FB660-MH1

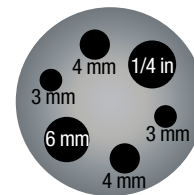

FB350-MH2, FB660-MH2

## STANDARD ACCESSORIES

- Power Cord
- RS-232 Cable
- User Guide
- Accredited Calibration Certificate
- LEMO Connector for reference sensor (R models only)
- Block Insulator (in FB150)
- Tongs (insert removal tool)

## OPTIONAL ACCESSORIES

- Transport Case for temperature block
- Inserts

# Beamex FB

## FIELD TEMPERATURE BLOCK

Lightweight, highly accurate temperature dry block for industrial field use. The Beamex field temperature block (FB) is an ideal temperature block for industrial field use. It is lightweight and easy to carry. It is an extremely quick dry block, yet it provides excellent accuracy.

110

### Available models

- FB150 / FB150R with range  $-25\text{ °C} \dots +150\text{ °C}$
- FB350 / FB350R with range  $+33\text{ °C} \dots +350\text{ °C}$
- FB660 / FB660R with range  $+50\text{ °C} \dots +660\text{ °C}$

The R models include an internal reference thermometer with a connection for an external reference sensor.

### Smart reference probes

Beamex smart reference probes are high-quality extremely stable reference PRT probes with an integrated memory which stores the individual probe coefficients. They are available in two versions: 300 mm straight version or a 90° bent version.



### Main features

- ▶ Lightweight, portable and quick field block
- ▶ Highly accurate
- ▶ Temperature ranges from a  $-25\text{ °C}$  to  $+660\text{ °C}$
- ▶ Dual zone control techniques enable excellent stability and uniformity
- ▶ Accredited calibration certificate as standard
- ▶ Part of the Beamex integrated calibration solution

# BEAMEX SMART REFERENCE PROBES



## Smart reference probes

The Beamex smart reference probe is a high-quality and extremely stable PRT probe with an integrated memory that stores the individual sensor coefficients. The sensor works as plug-and-play with Beamex FB series of temperature blocks (R model). The temperature block automatically reads the sensor coefficients from the sensor and makes the necessary adjustments. This

eliminates the need to enter the coefficients manually. The sensor can also be used with the Beamex MB series of temperature blocks (R model). The sensor coefficients can be manually entered via the MB user interface. The sensor is available as a 300 mm straight version or a 90° bent version, making it an ideal reference sensor for the Beamex temperature block.

### MAIN FEATURES:

- Temperature range -200 °C... 420 °C / 660 °C
- High stability, up to  $\pm 0.007$  °C
- 300 mm straight and 90° bent versions
- Accredited calibration certificate with data and ITS-90 coefficients included as standard

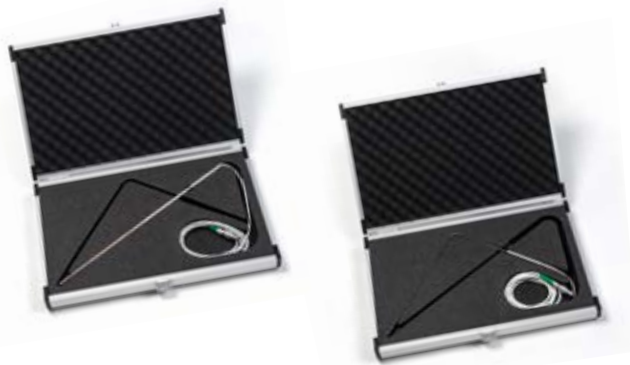

MODEL	DESCRIPTION
RPRT-420-300	Reference PRT, max 420 °C, length 300 mm, straight
RPRT-420-230A	Reference PRT, max 420 °C, length 230 mm (before angle), 90° angled
RPRT-660-300	Reference PRT, max 660 °C, length 300 mm, straight
RPRT-660-230A	Reference PRT, max 660 °C, length 230 mm (before angle), 90° angled

70877148758134753043  
 87984654546546  
 7587465465465132132131  
 62567565636458734657  
 665387875684653400

## SPECIFICATIONS

PARAMETER	RPRT-420-300 & RPRT-420-230A	RPRT-660-300 & RPRT-660-230A
Temperature range	-200 to 420 °C	-200 to 660 °C
Nominal resistance at 0.010 °C	100 Ω ±0.5 Ω	100 Ω ±0.5 Ω
Temperature coefficient	0.003925 Ω/Ω/°C	0.0039250 Ω/Ω/°C
Sheath diameter x length	6.35 mm ±0.08 mm x 305 mm ±0.08 mm (0.25 in ±0.003 x 12 in ±0.13 in)	6.35 mm ±0.08 mm x 305 mm ±0.08 mm (0.25 in ±0.003 x 12 in ±0.13 in)
Short-term repeatability <sup>1)</sup>	±0.007 °C at 0.010 °C ±0.013 °C at max temp	±0.007 °C at 0.010 °C ±0.013 °C at max temp
Drift <sup>2)</sup>	±0.007 °C at 0.010 °C ±0.013 °C at max temp	±0.007 °C at 0.010 °C ±0.013 °C at max temp
Hysteresis	±0.010 °C maximum	±0.010 °C maximum
Sensor length	30 mm ±5 mm (1.2 in ±0.2 in)	30 mm ±5 mm (1.2 in ±0.2 in)
Sensor location	3 mm ±1 mm from tip (0.1 in ±0.1 in)	3 mm ±1 mm from tip (0.1 in ±0.1 in)
Sheath material	Inconel 600	Inconel 600
Maximum immersion (nominal)	Straight: 305 mm (12 in) Angled: 210 mm (8.3 in)	Straight: 305 mm (12 in) Angled: 210 mm (8.3 in)
Minimum immersion (<5 mK error)	100 mm (3.9 in)	100 mm (3.9 in)
Minimum insulation resistance	500 MΩ at 23 °C	500 MΩ at 23 °C, 10 MΩ at 670 °C
Transition junction temperature range <sup>3)</sup>	-50 °C to 200 °C	-50 °C to 200 °C
Transition junction dimensions	71 mm x 12.5 mm (2.8 in x .42 in)	71 mm x 12.5 mm (2.8 in x .42 in)
Typical response time	12 seconds	12 seconds
Self heating (in 0 °C bath)	50 mW/°C	50 mW/°C
Lead-wire cable	Teflon cable, Teflon insulated, 24 AWG stranded, silverplated copper	Teflon cable, Teflon insulated, 24 AWG stranded, silver plated copper
Lead-wire length	1.8 m (6 ft)	1.8 m (6 ft)
Lead-wire temperature range	-50 °C to 250 °C	-50 °C to 250 °C
Warranty	Warranty 1 Year	Warranty 1 Year

1) Three thermal cycles from min to max temp, includes hysteresis, 95% confidence

2) After 100 hrs at max temp, 95% confidence

3) Temperatures outside this range will cause irreparable damage. For best performance, transition junction should not be too hot to touch.





# INDUSTRIAL PLATINUM RESISTANCE THERMOMETER

**beamex**  
A BETTER WAY TO CALIBRATE



113

## Beamex IPRT-300 Pt100 probe

The Beamex IPRT-300 is a robust industrial general-purpose temperature probe. It can be used up to +300°C (+572°F) temperature. The IPRT-300 provides a good accuracy of  $\pm 0.04$  °C when used with the provided CvD coefficients. The probe is a standard IEC60751 Pt100 (385) probe, so it can be used also without correction

coefficients, providing better than 1/5 DIN accuracy. The IPRT-300 is provided with a Lemo connector, so it can be plugged in to Beamex MC6 family calibrators and Beamex dry blocks. The probe comes with an accredited calibration certificate with the CvD coefficients included as standard.

### MAIN FEATURES:

- A robust industrial temperature probe for multiple purposes
- Temperature range  $-45$  °C ...  $+300$  °C ( $-49$  °F ...  $572$  °F)
- Accuracy up to  $\pm 0.04$  °C with CvD coefficients
- Provided with a 6 Pin connector compatible with Beamex MC6 family calibrator and Beamex dry blocks
- Comes with an accredited calibration certificate with CvD coefficients included



### SPECIFICATIONS

FEATURE	SPECIFICATION
Structure	Pt100 4-wire connection wire wound in stainless steel casing
Temperature range	$-45$ °C ... $+300$ °C ( $-49$ °F ... $572$ °F)
Accuracy (with CvD coefficients) <sup>(1)</sup>	0.04 °C
Accuracy (without CvD coefficients) <sup>(1)</sup>	0.06 °C + 0.1% RGD (1/5 IEC 60751 class B)
Dimensions	$\varnothing$ 3 mm x 250 mm (0.12" x 9.84")
Cable	3.0 m (9.84') long Teflon/Silicon cable
Connector	6 Pin Lemo connector, compatible with several Beamex products
Weight	~ 110 g (0.24 lb)
Calibration	Accredited calibration certificate included as standard, including the CvD coefficients
Warranty	1 year

1) Excluding calibration uncertainty

To use the IPRT-300 probe with a calibrator with four banana plugs, please use the adapter (code 8120500) available as an optional accessory.

70877240759834753043  
87884654595546  
7587465465465132132131  
62567565836458734657  
6553878755894653400

## SHORT INDUSTRIAL RESISTANCE THERMOMETER

**beamex**  
A BETTER WAY TO CALIBRATE



114

# Beamex SIRT-155 Pt100 probe

The Beamex SIRT-155 is a very short temperature probe provided with a thin flexible cable.

SIRT-155 is a great solution to be used as a short reference sensor when calibrating short sanitary sensors with Beamex MC6-T150 temperature calibrator. But SIRT-155 can be also used as a general-purpose small temperature sensor.

SIRT-155 offers a temperature range from -30 °C to 155 °C (-22 to 311 °F).

SIRT-155 is a standard IEC60751 Pt100 sensor and can be used without any coefficients. If you need better accuracy, you can use the probe with the provided ITS-90 coefficients.

SIRT-155 is provided with a handy Lemo connector, so it can be easily connected into several Beamex calibrators. With an adapter cable to 4 banana plugs, it can be also connected into any Pt100 measuring device.

### MAIN FEATURES:

- Short sensor with thin flexible cable
- Optimal for calibration of short sanitary sensors
- Temperature range -30 °C to 155 °C (-22 to 311 °F)
- Provided with a 6 pin Lemo connector compatible with many Beamex calibrators
- Comes with an accredited calibration certificate with data and ITS-90 coefficients

### SPECIFICATIONS



FEATURE	SPECIFICATION
Structure	Platinum ThinFilm Pt100 4-wire connection in stainless steel casing
Temperature range	-30 °C to 155 °C (-22 to 311 °F)
Accuracy with ITS-90 coefficients <sup>(1)</sup>	0.02 °C
Accuracy without ITS-90 coefficients <sup>(1)</sup>	IEC 60751 Class A (0.15 °C + 0.02% of reading)
Dimensions	Ø 3 mm x 30 mm (0.12" x 1.18"), 10 mm (0.39") bending protection
Cable	1.5 m (4.92') long PTFE cable
Connector	6 Pin Lemo connector, compatible with several Beamex products
Weight	~ 28 g (0.06 lb)
Calibration	Accredited calibration certificate included as standard, including data and ITS-90 coefficients
Warranty	1 year

1) Excluding calibration uncertainty

To use the SIRT-155 probe with a calibrator with four banana plugs, please use the adapter (code 8120500) available as an optional accessory.

150843  
7987465465465132132131  
05287565038458734657  
665387875684653400

# Beamex POC8

AUTOMATIC PRESSURE CONTROLLER

79977348759834759833  
87984654546546  
79977348759834759833  
655387875684653403

115



Pressure calibration made fast and easy

# An accurate and user-friendly automatic pressure output controller

The Beamex POC8 is an accurate and user-friendly automatic pressure output controller, providing regulated output from vacuum to 210 bar (3045 psi). A POC8 can be equipped with 1–2 internal measurement modules and an optional barometric module. The POC8 can be delivered as a panel mounted to the Beamex MCS200 modular test and calibration system or as a portable desk top version.

The POC8 can be used as a stand-alone pressure controller or it can be integrated into the Beamex calibration system. Together with the MC6 and Beamex CMX calibration software, the POC8 offers a fully automated, integrated solution for performing, documenting and managing calibrations easily, efficiently and accurately.

116

## Main features of the POC8

### User friendly

With its 7" color LCD display with touch screen, the POC8 is fast and efficient to use. The user interface includes more than 10 different language options.

### Panel mounted to a Beamex workstation

The POC8 can be used as panel mounted to a Beamex MCS200 modular test and calibration system.

### Desk top version

The POC8 can also be used as a desk top pressure controller, which makes it a very mobile solution.

### Part of Beamex integrated calibration solution

Together with the Beamex MC6 or MC6 Workstation calibrators as well as the Beamex CMX calibration management software, the POC8 offers an integrated, automated calibration system for performing, documenting and managing calibrations easily and efficiently.



# General specifications

FEATURE	SPECIFICATION
Display	7" color LCD display with resistive touch screen
Weight	12.7 kg (28 lb) (with all modules installed)
Dimensions	Portable: 346(w) x 145(h) x 388 (d) mm Panel mounting: 400 (w) x 200 (h) mm
Communication	USB
Power consumption	max 150 VA
Warranty	2 years
Supported User interface languages	English, German, French, Spanish, Italian, Japanese, Chinese, Korean, Polish, Portuguese, Russian
Connections	Pressure supply, vacuum supply, measure/control. All connections 7/16-20 F UNF, provided with low or high pressure adapters.

## SPECIFICATIONS

FEATURE	SPECIFICATION			
Available ranges	<b>CONTROL UNIT</b>			
	<b>MEASUREMENT RANGE</b>	<b>10 bar / 145 psi</b>	<b>100 bar / 1450 psi</b>	<b>210 bar / 3045 psi</b>
	± 350 mbar / 5 psi	•	-	-
	± 1 bar / 14.5 psi	•	-	-
	Vacuum to 6 bar / 87 psi	-	•	-
	Vacuum to 20 bar / 290 psi	-	•	•
	Vacuum to 100 bar / 1450 psi	-	•	•
	Vacuum to 210 bar / 3045 psi	-	-	•
	Custom range within -1 ... 210 bar	•	•	•
	Barometric module	•	•	•
The maximum controlled pressure is the same as the highest installed pressure measurement range.				
1 year uncertainty	0.02% of span (active range)			
Pressure units	38 units and two user programmable			
Control stability	0.005% of Span (active range)			
Test volume	0 ... 1,000 ccm			
Pressure media	Dry, clean air or nitrogen			
Overpressure protection	Safety relief valve fixed			
Resolution	4 to 6 digits			
Max overpressure	Supply port 110% FS Measure/control port: 105% FS			
Supply pressure range	Maximum 110% FS of control range. Minimum 1.38bar (20 psi) over the required controlled pressure.			
Operation temperature	15 to 45°C			

## INSTALLATION ALTERNATIVES

- Portable unit
- Panel mounted to a workstation

## OPTIONS

- Barometric precision reference
  - enables absolute range
- Panel mounting kit

## STANDARD ACCESSORIES

- User guide
- Accredited calibration certificate
- Mains cable
- Connecting kits for:
  - High pressure and vacuum supply or
  - Low pressure and vacuum supply with appropriate pressure adapters and hoses

## OPTIONAL ACCESSORIES

- Beamex DMT dirt and moisture trap
- Pressure hoses and connectors

# Beamex POC8

## AUTOMATIC PRESSURE CONTROLLER

118

The Beamex POC8 is an accurate and user-friendly automatic pressure output controller, providing regulated output from vacuum to 210 bar (3045 psi). A POC8 can be equipped with 1–2 internal measurement modules and an optional barometric module. The POC8 can be delivered as a panel mounted to the Beamex MCS200 modular test and calibration system or as a portable desk top version. The POC8 can be used as a stand-alone pressure controller or it can be integrated into the Beamex calibration system. Together with the MC6 and Beamex CMX calibration software, the POC8 offers a fully automated, integrated solution for performing, documenting and managing calibrations easily, efficiently and accurately.

### User friendly

With its 7" color LCD display with touch screen, the POC8 is fast and efficient to use. The user interface includes more than 10 different language options.

### Panel mounted to a Beamex workstation

The POC8 can be used as panel mounted to a Beamex MCS200 modular test and calibration system.

### Portable desk top version

The POC8 can also be used as a desk top pressure controller, which makes it a very mobile solution.

### Part of Beamex integrated calibration solution

Together with the Beamex MC6 or MC6 Workstation calibrators as well as the Beamex CMX calibration management software, the POC8 offers an integrated, automated calibration system for performing, documenting and managing calibrations easily and efficiently.



### Main features

- ▶ User-friendly
- ▶ Part of the Beamex integrated calibration solution
- ▶ Can be used as a stand-alone pressure controller
- ▶ Automatic pressure calibrations
- ▶ Portable or bench mounted

# Beamex PG

PRESSURE GENERATORS

79877348759834759833  
87984654546546  
79877348759834759833  
655387875684653400



119

Beamex PGM | PGV | PGC | PGHH | PGPH | PGL

Beamex PG pressure generators are portable hand-operated pressure generators and ultimate field calibration pumps

**beamex**  
A BETTER WAY TO CALIBRATE

# Calibration pumps

120





# PGM

PRESSURE GENERATOR MEDIUM 0...20 bar / 0...300 psi



121

**The PGM** is a hand-operated pressure calibration pump that uses air as its pressure medium. The extremely accurate volume control provides the excellent fine adjustment of pressure. The pump's unique and sturdy construction makes the PGM the ultimate field calibration pump.

## Specifications

PGM, PRESSURE GENERATOR MEDIUM	
Output pressure:	0 ... 20 bar / 0 ... 300 psi
Pressure media:	Air
Outlet connector:	2 x 1/8" NPT female
Dimensions:	223 mm x 96 mm x 38 mm 8.78" x 3.78" x 1.5"
Weight:	400 g / 0.9 lb
Standard delivery:	<ul style="list-style-type: none"><li>• Service seal kit</li><li>• Opening tool</li><li>• Output adapters:<ul style="list-style-type: none"><li>– G 1/8" male 60° int. cone</li><li>– 2 x connector for 1/8" ID hose</li><li>– 2 x connector for 1/8" ID / 1/4" OD hose with nut</li><li>– plug</li></ul></li></ul>
Optional accessories:	<ul style="list-style-type: none"><li>• Carrying case</li><li>• Hose 1.5 m</li><li>• T-tubing set with connectors</li></ul>

# PGV

VACUUM GENERATOR 0...–0.95 bar / 0...–13.7 psi



122

**The PGV** is a highly efficient vacuum pump generating vacuum quickly using a pulling action. The extensive volume control provides fine adjustment of the generated vacuum. The compact, sturdy and lightweight construction is designed for use in tough field environments.

## Specifications

PGV, PRESSURE GENERATOR VACUUM	
Output pressure:	0 ... –0.95 bar / 0 ... –13.7 psi
Pressure media:	Air
Outlet connector:	G 1/8" male 60° int. cone
Dimensions:	Diameter 35 mm / 1.38" Length, min 230 mm / 9.06" Length, max 322 mm / 12.68"
Weight:	340 g / 0.75 lb
Standard delivery:	<ul style="list-style-type: none"><li>• Service seal kit</li><li>• Opening tool</li><li>• R 1/8" 60° female to 1/4 NPT male for connecting the pressure measurement hose to the instrument to be calibrated.</li><li>• Pressure hose 0.75 m / 2'5 1/2" with R 1/8" 60° male connector at both ends</li></ul>
Optional accessories:	<ul style="list-style-type: none"><li>• Carrying case</li><li>• T-tubing set with connectors</li><li>• 1.5 m / 4'9 hose</li></ul>

# PGC

PRESSURE/VACUUM GENERATOR –0.95...35 bar / –13.7...510 psi

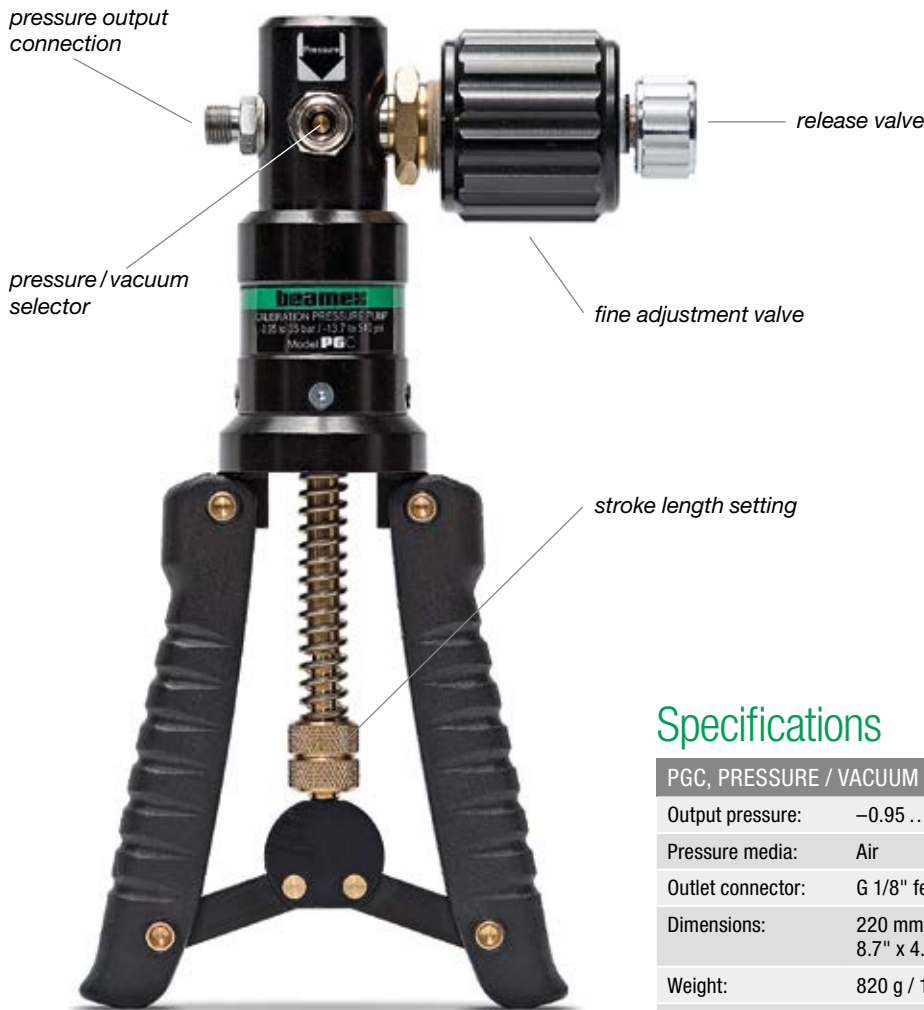

123

## Specifications

PGC, PRESSURE / VACUUM GENERATOR	
Output pressure:	–0.95 ... 35 bar / –13.7 ... 510 psi
Pressure media:	Air
Outlet connector:	G 1/8" female with a 60° male internal conical adaptor
Dimensions:	220 mm x 120 mm x 65 mm 8.7" x 4.7" x 2.6"
Weight:	820 g / 1.81 lb
Standard delivery:	<ul style="list-style-type: none"><li>• Pump</li><li>• 40 bar / 580 psi pressure T-hose</li><li>• Connector kit:<ul style="list-style-type: none"><li>– G 1/8" male, 60° internal cone / G 1/8" male + O-ring</li><li>– G 1/8" male, 60° internal cone / G 1/4" B female + 2 seals</li><li>– G 1/8" male, 60° internal cone / G 1/4" NPT male</li></ul></li><li>• Carrying case</li><li>• Instruction manual</li></ul>
Optional accessories:	<ul style="list-style-type: none"><li>• Service seal kit containing a set of seals and gaskets</li><li>• Fine adjustment valve including relief valve and gaskets</li><li>• Upper part of pump (cylinder) including pressure/vacuum selector</li><li>• Bottom part including handles and pistons</li></ul>

**The PGC** is a hand-operated calibration pump that can be used to generate pressure and vacuum. Using the pressure/vacuum selector you can quickly select if you want to generate pressure or vacuum. The fine adjustment provide means to accurately fine adjust the generated pressure.

# PGHH

PRESSURE GENERATOR HYDRAULIC HIGH 0...700 bar / 0...10000 PSI

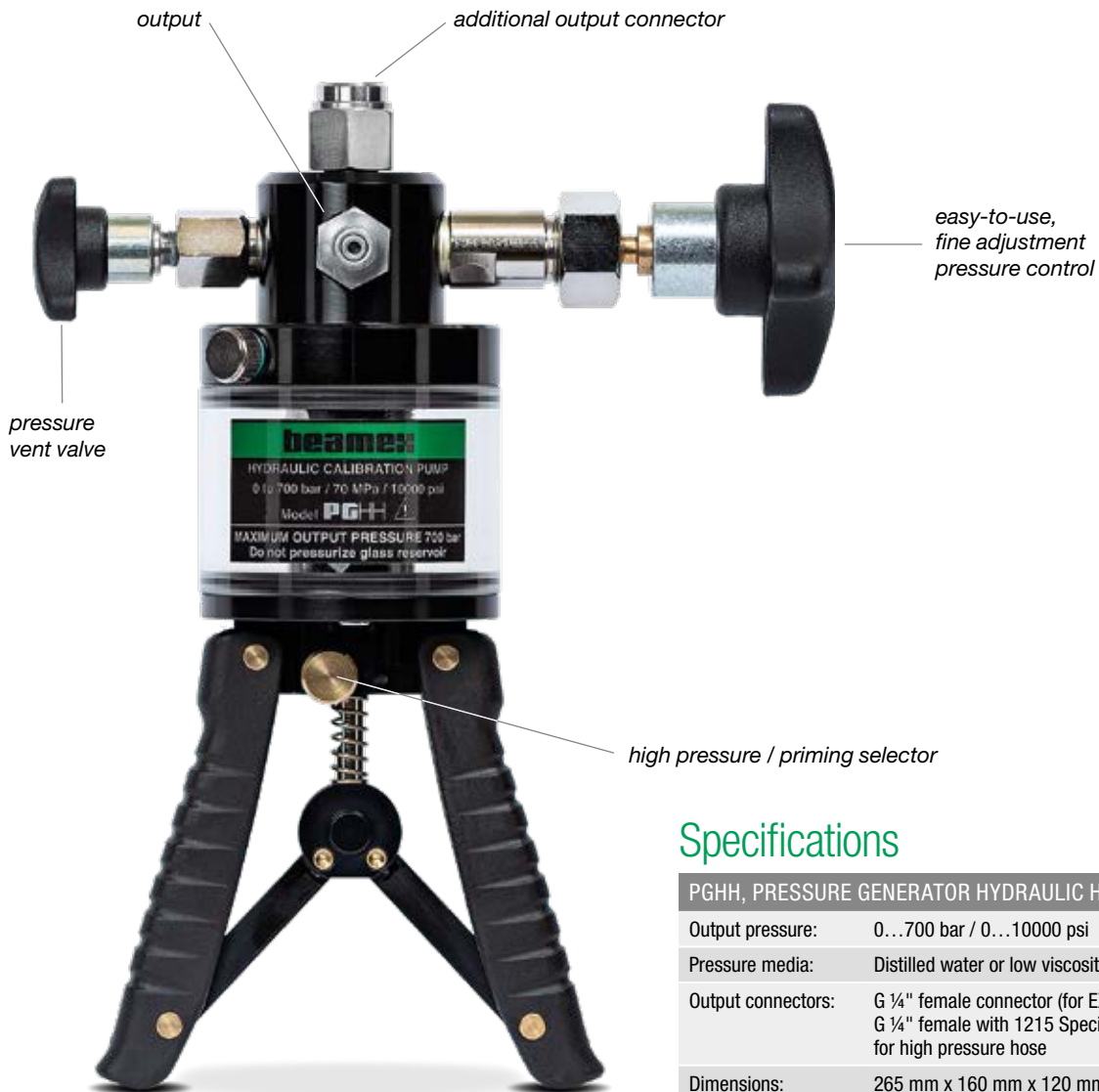

124

**The PGHH** is a hand-operated, hydraulic, high-pressure generator compatible with different liquids (e.g. mineral oil, distilled water, etc.). The pump is equipped with an adjustable volume control for fine-tuning generated pressure. PGHH also includes a prime/high stroke selector for easy use.

## Specifications

PGHH, PRESSURE GENERATOR HYDRAULIC HIGH	
Output pressure:	0...700 bar / 0...10000 psi
Pressure media:	Distilled water or low viscosity mineral oil
Output connectors:	G 1/4" female connector (for EXT pressure module) G 1/4" female with 1215 Special male adaptor for high pressure hose
Dimensions:	265 mm x 160 mm x 120 mm 10.4" x 6.3" x 4.7"
Weight:	1.3 kg / 2.87 lb
Standard delivery:	<ul style="list-style-type: none"><li>• PGHH Pump</li><li>• Carrying case</li><li>• A 1 meter (3.28 feet) high-pressure hose with two 1215 Special female connectors and a 1/4" NPT male / 1215 Special male adaptor for device under test</li><li>• Sealing rings</li><li>• Refill bottle</li><li>• User manual</li></ul>
Optional accessories:	<ul style="list-style-type: none"><li>• High pressure hoses and adaptors</li><li>• Sealing rings</li><li>• Maintenance kit</li></ul>

# PGPH

PRESSURE GENERATOR PNEUMATIC HIGH –0.95...140 bar / –13.7...2000 psi



125

## Specifications

PGPH, PRESSURE GENERATOR PNEUMATIC HIGH	
Pressure range:	–0.95...140 bar / –13.7...2000 psi
Output threads:	2 x G 1/4" female
Temperature:	0...50 °C / 32...122 °F
Humidity:	< 85% RH
Adjusting sensitivity:	0.1 mbar (0.001 psi)
Safety pressure:	< 180 bar (2600 psi)
Pressure media:	Air
Dimensions:	54 cm x 27 cm x 18 cm 21.26" x 10.63" x 7.09"
Weight:	7.1 kg / 15.7 lb
Standard delivery:	<ul style="list-style-type: none"><li>• Output connectors:<ul style="list-style-type: none"><li>– G 1/4" (Male) Plug x 1</li></ul></li><li>• A small bag (20 pcs.) of o-rings (sealing rings) type: NBR70 (size 6x2)</li><li>• User guide</li></ul>
Optional accessories:	<ul style="list-style-type: none"><li>• Carrying case</li><li>• Maintenance kit</li><li>• Lubricant for the axle of fine adjustment</li><li>• High pressure hose 1 m with G 1/4" and G 1/8" male connectors for connecting the pump to the calibrator's internal high pressure module (not needed if an external high pressure module is available)</li><li>• High pressure hose 1 m with G 1/4" and 1/4" NPT connectors for connecting the pump to the instrument</li></ul>

**The PGPH** is a hand-operated pneumatic (air as pressure medium) high-pressure table pressure generator. The pump is efficient in generating both vacuum and high pressure up to 140 bar (2000 psi) quickly and effortlessly. It takes less than one minute to generate the maximum pressure. The PGPH is equipped with an adjustable volume control, providing excellent fine-tuning of generated pressure, and two hand-tight connectors allowing fast and easy connections without the need for any tools.

# PGL

PRESSURE GENERATOR LOW –400...400 mbar / –160...160 iwc



126

## Specifications

PGL, PRESSURE GENERATOR LOW	
Pressure range:	–400...400 mbar / –160...160 iwc
Output threads:	1 x G 1/8" female
Output adapters (hand-tightened and removable):	Standard delivery: <ul style="list-style-type: none"><li>• G 1/8" / 60–G1/8"</li><li>• Nipple for 4 mm ID hose</li></ul>
Temperature:	0...50 °C / 32...122 °F
Humidity:	< 95% RH
Adjusting sensitivity:	1 Pa / 0.01 mbar / 0.1 mmH <sub>2</sub> O / 0.004 inH <sub>2</sub> O
Safety pressure:	< 4 bar / 1 600 iwc
Pressure media:	Air
Dimensions:	24 cm x 11 cm x 14 cm 9.45" x 4.33" x 5.51"
Weight:	1.2 kg / 2.6 lb
Standard delivery:	<ul style="list-style-type: none"><li>• Output Connectors:<ul style="list-style-type: none"><li>– G 1/8" / 60–G1/8" installed in the pump</li><li>– Nipple for 4 mm ID hose</li></ul></li><li>• A small bag (10 pcs.) of o-rings in size and type: 10.1 mm x 1.6 mm NBR 70</li><li>• User Guide</li></ul>
Optional accessories:	<ul style="list-style-type: none"><li>• Carrying case</li><li>• Maintenance kit</li><li>• Extra output Connectors (same as in the standard delivery)</li><li>• Lubricant for the axle of the pressure adjust and fine adjustment handles</li></ul>

**The PGL** is a hand-operated pressure table pump for low pressure using air as its pressure medium. The pump is equipped with an isothermal bellows chamber for reducing possible environmental temperature changes during the calibration process. With the screw-operated volume control and fine adjustment, an extremely accurate and stable pressure adjustment is possible.

# Beamex EXT

EXTERNAL PRESSURE MODULES



127

## Increased usability with EXT modules

The Beamex EXT external pressure modules introduce new configuration possibilities and add flexibility, as it is possible to calibrate more pressure ranges with the same calibrator. This way, the Beamex calibration equipment meets your needs even better. Beamex offers a wide range of external pressure modules – from vacuum to 1000 bar / 14 500 psi. External pressure modules are compatible with Beamex MC calibrators.

**beamex**  
A BETTER WAY TO CALIBRATE

79977348759834759833  
87984654546546  
79977348759834759833  
655387875684653403

# External pressure modules

MODULES <sup>1)</sup>	RANGE <sup>2)</sup>	RESOLUTION	ACCURACY <sup>3)</sup> (±)	1 YEAR UNCERTAINTY <sup>4)</sup> (±)
EXT B EXT B-IS	70 to 120 kPa a 700 to 1200 mbar a 10.15 to 17.4 psi a	0.01 0.1 0.001	0.03 kPa 0.3 mbar 0.0044 Psi	0.05 kPa 0.5 mbar 0.0073 psi
EXT10mD EXT10mD-IS	±1 kPa diff ±10 mbar diff ±4 iwc diff	0.0001 0.001 0.001	0.05% Span	0.05% Span + 0.1% RDG
EXT100m EXT100m-IS	0 to 10 kPa 0 to 100 mbar 0 to 40 iwc	0.0001 0.001 0.001	0.015% FS + 0.0125% RDG	0.025% FS + 0.025% RDG
EXT400mC EXT400mC-IS	±40 kPa ±400 mbar ±160 iwc	0.001 0.01 0.001	0.01% FS + 0.0125% RDG	0.02% FS + 0.025% RDG
EXT1C EXT1C-IS	±100 kPa ±1 bar -14.5 to 15 psi	0.001 0.00001 0.0001	0.007% FS + 0.0125% RDG	0.015% FS + 0.025% RDG
EXT2C EXT2C-IS	-100 to 200 kPa -1 to 2 bar -14.5 to 30 psi	0.001 0.00001 0.0001	0.005% FS + 0.01% RDG	0.01% FS + 0.025% RDG
EXT6C EXT6C-IS	-100 to 600 kPa -1 to 6 bar -14.5 to 90 psi	0.01 0.0001 0.001	0.005% FS + 0.01% RDG	0.01% FS + 0.025% RDG
EXT20C EXT20C-IS	-100 to 2000 kPa -1 to 20 bar -14.5 to 300 psi	0.01 0.0001 0.001	0.005% FS + 0.01% RDG	0.01% FS + 0.025% RDG
EXT60 EXT60-IS	0 to 6000 kPa 0 to 60 bar 0 to 900 psi	0.1 0.001 0.01	0.005% FS + 0.0125% RDG	0.01% FS + 0.025% RDG
EXT100 EXT100-IS	0 to 10 MPa 0 to 100 bar 0 to 1500 psi	0.0001 0.001 0.01	0.005% FS + 0.0125% RDG	0.01% FS + 0.025% RDG
EXT160 EXT160-IS	0 to 16 MPa 0 to 160 bar 0 to 2400 psi	0.0001 0.001 0.01	0.005% FS + 0.0125% RDG	0.01% FS + 0.025% RDG
EXT250 EXT250-IS	0 to 25 MPa 0 to 250 bar 0 to 3700 psi	0.001 0.01 0.1	0.007% FS + 0.0125% RDG	0.015% FS + 0.025% RDG
EXT600 EXT600-IS	0 to 60 MPa 0 to 600 bar 0 to 9000 psi	0.001 0.01 0.1	0.007% FS + 0.01% RDG	0.015% FS + 0.025% RDG
EXT1000 EXT1000-IS	0 to 100 MPa 0 to 1000 bar 0 to 15000 psi	0.001 0.01 0.1	0.007% FS + 0.01% RDG	0.015% FS + 0.025% RDG
<b>Dimension:</b>	145 x 45 x 55 mm / 5.7" x 1.8" x 2.2"		<b>Weight:</b>	0.5 kg / 1.1 lb
<b>Operating temperature:</b>	-10 ... +50 °C / 14 ... 122 °F		<b>Storage temperature:</b>	-20 ... +60 °C / -4 ... 140 °F
<b>Warranty:</b>	Warranty 3 Years			

Temperature coefficient ±0.001% Rdg/°C outside 15...35 °C (59...95 °F)

INT10mD / EXT10mD < ±0.002% Span/°C outside 15...35 °C (59...95°F)

1) IS version available for all external pressure modules

2) Every internal/external pressure module's range may also be displayed in absolute pressure if the Barometric Module (B) is installed.

3) 'Accuracy' includes hysteresis, nonlinearity, repeatability and reference standard uncertainty (k=2).

4) '1 Year Uncertainty' includes hysteresis, nonlinearity, repeatability and typical long-term stability for mentioned period (k=2).

All external pressure modules (EXT) are also compatible with Beamex MC6, MC6-T, MC6 Workstation, MC5, MC4, MC2 and MC5P calibrators. All intrinsically safe external pressure modules (EXT-IS) are compatible with Beamex MC6-Ex, MC5-IS and MC2-IS calibrators.

Supports the following pressure units as standard: Pa, hPa, kPa, MPa, mbar, bar, lbf/ft<sup>2</sup>, psi, gf/cm<sup>2</sup>, kgf/cm<sup>2</sup>, kgf/m<sup>2</sup>, kp/cm<sup>2</sup>, at, mmH<sub>2</sub>O, cmH<sub>2</sub>O, mH<sub>2</sub>O, iwc, ftH<sub>2</sub>O, mmHg, cmHg, mHg, inHg, mmHg(0 °C), inHg(0 °C), mmH<sub>2</sub>O(4 °C), inH<sub>2</sub>O(4 °C), ftH<sub>2</sub>O(4 °C), inH<sub>2</sub>O(60°F), mmH<sub>2</sub>O(68°F), inH<sub>2</sub>O(68°F), ftH<sub>2</sub>O(68°F), torr, atm.

INT B / EXT B; M5 (10/32") female.

INT10mD and EXT10mD; Two M5 (10/32") female threads with a hose nipple included.

INT100m/EXT100m – INT20C/EXT20C; G1/8" (ISO228/1) female. A conical 1/8" BSP male with 60° internal cone adapter included for Beamex hose set.

INT60, INT100, INT160; G1/8" (ISO228/1) female. EXT60, EXT100, EXT160, EXT250, EXT600, EXT1000; G 1/4" (ISO228/1) male.

Wetted parts AISI316 stainless steel, Hastelloy, Nitrile rubber.

Maximum overpressure: B module; 1200 mbar abs. 10mD module; 200 mbar. EXT600; 900 bar. EXT1000; 1000 bar.

For all other modules, the maximum overpressure is twice the nominal range.

HART is a registered trademark of HART Communication Foundation.



# CALIBRATION BENCHES



# PORTABLE CALIBRATORS



# PROFESSIONAL SERVICES



# CALIBRATION SOFTWARE



# beamex

A BETTER WAY TO CALIBRATE

[www.beamex.com](http://www.beamex.com)